



KOCHPLATTEN

Heizkörper und Zubehör für Elektroherde

Großkochfeldheizkörper, Kochplatten und Strahlungsheizkörper



Zubehör

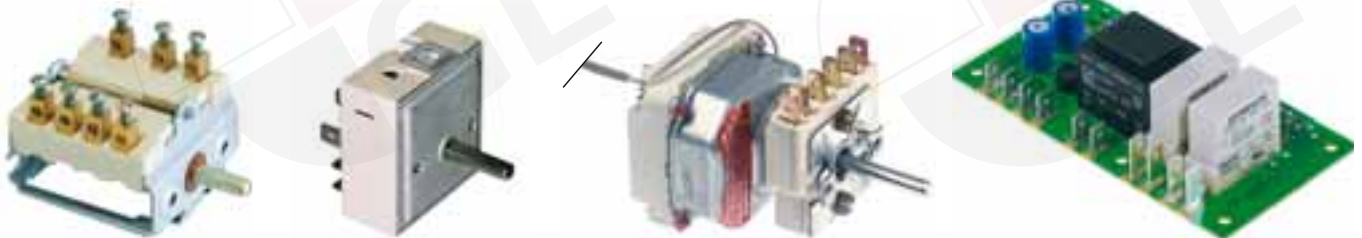

EGOTHERM-Heizböden



GEV GmbH
Großküchen-Ersatzteil-Vertrieb
Robert-Koch-Straße 3a
82152 Planegg/München
Deutschland

Telefon: +49 (0)89 745572-0
Telefax: +49 (0)89 745572-82
E-Mail: info@gev-online.de
Internet: www.gev-online.de



GEV GmbH
Ersatzteile und Zubehör
Kanalstrasse 14
5745 Safenwil
Schweiz

Telefon: +41 (0)62 797 87 70
Telefax: +41 (0)62 797 25 07
E-Mail: info@gev.ch
Internet: www.gev.ch



GEV Großküchen-
Ersatzteil-Vertriebs GesmbH
Austraße 12
5110 Oberndorf
Österreich

Telefon: +43 (0)6272 6688-0
Telefax: +41 (0)6272 6688-14
E-Mail: office@gev.at
Internet: www.gev.at

Members of the GEV GROUP

Automatik-Kochplatten



Seite 4

Kochplatten rund



Seite 4

Kochplatten quadratisch



Seite 5

Kochplatten rechteckig



Seite 6

Großkochfeld-Heizkörper



Seite 7

K

Kochplatten

Strahlungsheizkörper rund



Seite 9

Strahlungsheizkörper achteckig



Seite 9

Strahlungsheizkörper quadratisch



Seite 10

Strahlungsheizkörper rechteckig



Seite 10

Zubehör



Seite 12

EGOTHERM-Heizböden



Seite 18

Automatik-Kochplatten 4mm Überfallrand (Haushalt) mit Bolzenbefestigung



Pos.	Bestell-Nr.	ø (mm)	Leistung	Spannung	Vergleichs-Nr.
1	490036	145	1500W	230V	13.14356.020 13.14356.040

Automatik-Kochplatten 8mm Überfallrand (Haushalt) mit Bolzenbefestigung



Pos.	Bestell-Nr.	ø (mm)	Leistung	Spannung	Vergleichs-Nr.
1	490033	145	1500W	230V	12.14356.234 12.14356.232
2	490023	180	2000W	230V	12.18356.234 12.18356.232

mit Laschenbefestigung



Pos.	Bestell-Nr.	ø (mm)	Leistung	Spannung	Vergleichs-Nr.
1	490034	145	1500W	230V	12.14356.174 12.14356.172
2	490035	180	2000W	230V	12.18356.174 12.18356.172

Automatik-Kochplatten-Austauschset 8mm Überfallrand (Haushalt) mit Bolzenbefestigung



Pos.	Bestell-Nr.	ø (mm)	Leistung	Spannung	Vergleichs-Nr.
1	490059	145	1500W	230V	17.99014.112
2	490060	180	2000W	230V	17.99018.112

Automatik-Kochplatten-Thermostate



Abb.	Bestell-Nr.	Beschreibung	Vergleichs-Nr.
1	390401	Kapillare 600mm	76.01122.000
1	390402	Kapillare 1500mm	76.01125.000
2	390403	Kapillare 1500mm	76.03115.000

Kochplatten rund 4mm Überfallrand (Haushalt)

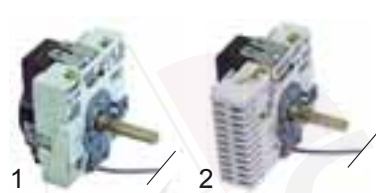

Pos.	Bestell-Nr.	ø (mm)	Leistung	Spannung	Anschlüsse	Vergleichs-Nr.
1	490001	145	1000W	230V	4	13.14453.040 13.14453.020
2	490004*	145	1500W	230V	4	13.14463.040 13.14454.040 13.14474.040 13.14463.020
3	490002	180	1500W	230V	4	13.18453.040 13.18453.020
4	490006*	180	2000W	230V	4	13.18463.040 13.18454.040 13.18474.040 13.18463.020
5	490003	220	2000W	230V	4	13.22453.040 13.22456.020

* mit Protektor

Kochplatten rund 8mm Überfallrand (Großküche und Haushalt)



Pos.	Bestell-Nr.	ø (mm)	Leistung	Spannung	Anschlüsse	Vergleichs-Nr.
1	416191	90	450W	230V	3	12.08353.017
2	490010	145	1000W	230V	4	12.14453.194 12.14453.022
3	490011	145	1000W	400V	4	12.14453.025 12.14453.021
4	490012*	145	1500W	230V	4	12.14463.196 12.14463.022
5	490013*	145	1500W	400V	4	12.14463.197 12.14463.021
6	490014	180	1500W	230V	4	12.18453.196 12.18453.022
7	490129*	180	1500W	230V	4	12.18474.140
8	490015	180	1500W	400V	4	12.18453.025 12.18453.021
9	490016*	180	2000W	230V	4	12.18463.194 12.18463.022
10	490017*	180	2000W	400V	4	12.18463.198 12.18463.021
11	490018	220	2000W	230V	4	12.22453.199 12.22453.022
12	490130*	220	2000W	230V	4	12.22474.140
13	490019	220	2000W	400V	4	12.22453.025 12.22453.021
14	490174	220	2000W	440V	4	12.22453.018
15	490020*	220	2600W	230V	4	12.22463.018 12.22463.012
16	490021*	220	2600W	400V	4	12.22463.019 12.22463.011
17	490175*	220	2600W	440V	4	12.22463.014
18	490061	300	2500W	230V	4	12.30453.194
19	490063	300	2500W	400V	4	12.30453.195
20	490062*	300	3500W	230V	4	12.30454.194
21	490064*	300	3500W	400V	4	12.30454.195

* mit Protektor

Kochplatten rund (Großküche) mit Schraubbefestigung



Abb.	Bestell-Nr.	ø (mm)	Leistung	Spannung	Anschlüsse	Vergleichs-Nr.
1a	490106	400	5000W	400V	2x3	12.40670.231
1b	490107	400	5000W	400V	4x2	12.40870.007 12.40870.001

mit 2 Knieanschlüssen



Pos.	Bestell-Nr.	ø (mm)	Leistung	Spannung	Anschlüsse	Vergleichs-Nr.
1	490103	400	5000W	400V	2x3	12.40650.001 12.40650.011

Kochplatten quadratisch mit Überfallrand (Großküche)



Pos.	Bestell-Nr.	Maße (mm)	Leistung	Spannung	Anschlüsse	Vergleichs-Nr.
1	490065	220x220	2000W	230V	4	11.22473.234 11.22473.232 11.22454.234
2	490067	220x220	2000W	400V	4	11.22473.235 11.22473.231 11.22454.235
3	490066*	220x220	2600W	230V	4	11.22454.237 11.22454.232
4	490068*	220x220	2600W	400V	4	11.22454.238 11.22454.231
5	490176*	220x220	2600W	440V	4	11.22454.264
6	490054*	300x300	2500W	230V	4	11.33473.238 11.33454.252 11.33454.232
7	490128*	300x300	2500W	400V	4	11.33473.231 11.33454.251 11.33454.231
8	490070	300x300	3000W	230V	4	11.33473.239 11.33473.235 11.33473.232
9	490073	300x300	3000W	400V	4	11.33473.338 11.33473.234 11.33473.231
10	490056*	300x300	3000W	230V	4	11.33454.247 11.33454.235 11.33454.232
11	490057*	300x300	3000W	400V	4	11.33454.248 11.33454.234 11.33454.231
12	490177	300x300	3000W	440V	4	11.33454.335
13	490141*	300x300	3500W	230V	4	11.33454.242
14	490071*	300x300	4000W	230V	4	11.33454.246 11.33454.238
15	490074*	300x300	4000W	400V	4	11.33454.249 11.33454.237

* mit Protektor

Kochplatten Quadratisch 300x300mm mit Kontaktstiften



Pos.	Bestell-Nr.	Maße (mm)	Leistung	Spannung	Anschlüsse	Vergleichs-Nr.
1	490075	300x300	2500W	230V	3	11.33310.009 11.33310.002
2	490076	300x300	2500W	400V	3	11.33310.008 11.33310.001
3	nml.	300x300	4000W	230V	4	11.33480.002
4	nml.	300x300	4000W	400V	4	11.33480.001

mit Schraubbefestigung



Pos.	Bestell-Nr.	Maße (mm)	Leistung	Spannung	Anschlüsse	Vergleichs-Nr.
1	490078	300x300	3000W	400V	4	11.33470.195
2	490162	300x300	4000W	230V	4	11.33460.192 11.33460.194
3	490161	300x300	4000W	400V	4	11.33460.195

mit Kippbefestigung



Pos.	Bestell-Nr.	Maße (mm)	Leistung	Spannung	Anschlüsse	Vergleichs-Nr.
1	490085	300x300	2500W	230V	3	11.33370.247 11.33370.242
2	490086	300x300	2500W	400V	3	11.33370.246 11.33370.241
3	nml.	300x300	2500W	230V	4	11.33460.302
4	490088	300x300	2500W	400V	4	11.33460.349 11.33460.301
5	490089	300x300	4000W	230V	4	11.33460.342 11.33460.308
6	490090	300x300	4000W	400V	4	11.33460.341 11.33460.307

mit Auflegerand



Pos.	Bestell-Nr.	Maße (mm)	Leistung	Spannung	Anschlüsse	Vergleichs-Nr.
1	490095	300x300	2500W	400V	4	11.33471.211
2	490097	300x300	4000W	400V	4	11.33461.266 11.33461.267

mit 1 Knieanschluss



Pos.	Bestell-Nr.	Maße (mm)	Leistung	Spannung	Anschlüsse	Vergleichs-Nr.
1	490163	300x300	3000W	400V	3	11.33450.507

Kochplatten quadratisch 400x400mm mit 2 Knieanschlüssen



Pos.	Bestell-Nr.	Maße (mm)	Leistung	Spannung	Anschlüsse	Vergleichs-Nr.
1	490105	400x400	5000W	400V	3+3	11.44650.001

mit Schraubbefestigungen



Pos.	Bestell-Nr.	Maße (mm)	Leistung	Spannung	Anschlüsse	Vergleichs-Nr.
1	490149	400x400	5000W	230V	4+2	11.44870.003
2	490178	400x400	5000W	400V	4+2	11.44870.001

Kochplatten rechteckig mit Schraubbefestigungen



Pos.	Bestell-Nr.	Maße (mm)	Leistung	Spannung	Anschlüsse	Vergleichs-Nr.
1	490110*	348x271	4000W	400V	4	11.32461.201

* mit Protektor



Pos.	Bestell-Nr.	Maße (mm)	Leistung	Spannung	Anschlüsse	Vergleichs-Nr.
1	490166	600x300	5000W	400V	4	11.63471.111



Pos.	Bestell-Nr.	Maße (mm)	Leistung	Spannung	Anschlüsse	passend für
1	416893	560x285	2x2600W	230V	2x3	Ascobloc Küppersbusch Palux



Pos.	Bestell-Nr.	Maße (mm)	Leistung	Spannung	Anschlüsse	passend für
1	490173	560x285	2x3000W	230V	2x4	Küppersbusch



Pos.	Bestell-Nr.	Maße (mm)	Leistung	Spannung	Anschlüsse	passend für
1	490165	400x350	4000W	400V	2x3	Therma Electrolux

Heizkörper



Abb.	Bestell-Nr.	Maße (mm)	Leistung	Spannung	Montage	passend für
1	415577	245x295	1160W	400V	innen	Therma Electrolux
2	415576	275x320	1335W	400V	mitte	
3	415575	360x395	1505W	400V	außen	

Kochringe

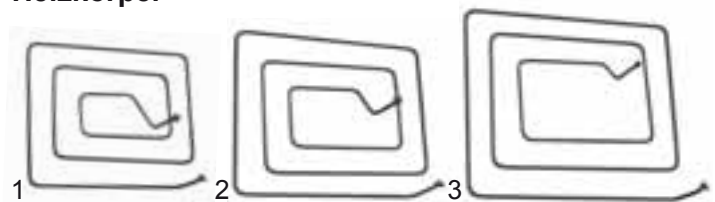

Abb.	Bestell-Nr.	ø (mm)	Leistung	Spannung	Vergleichs-Nr.
1	490032	80	350W	230V	
2	490022	145	1000W	230V	12.14025.142
3	490155*	160	1000W	230V	

* Siebentakttring

Großkochfeld-Heizkörper



Abb.	Bestell-Nr.	Maße (mm)	Leistung	Spannung	passend für
1	418009	380x287	4000W	400V	Juno Electrolux
2	418701	330x300	4000W	400V	Therma Electrolux



Abb.	Bestell-Nr.	Maße (mm)	Leistung	Spannung	passend für
1	418718	265x100	1500W	230V	Silko
2	416894	265x245	3500W	230V	Palux

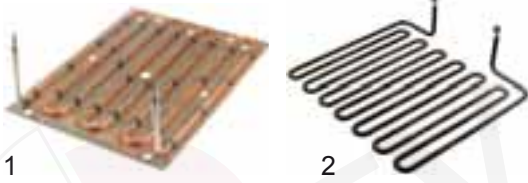

Pos.	Bestell-Nr.	Maße (mm)	Leistung	Spannung	passend für
1	418692	275x260	3860W	400V	Wamsler

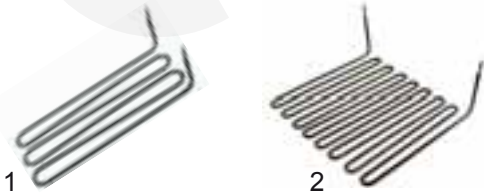

Abb.	Bestell-Nr.	Maße (mm)	Leistung	Spannung	passend für
1	418699	345x230	2000W	400V	Juno Electrolux
2	418700	380x265	2000W	400V	



Abb.	Bestell-Nr.	Maße (mm)	Leistung	Spannung	passend für
1	418697	270x230	2000W	400V	Juno Electrolux
2	418698	300x260	2000W	400V	

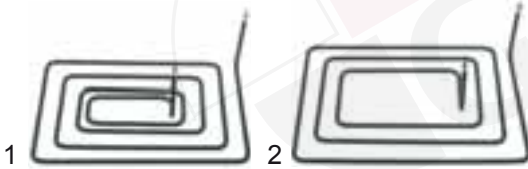

Abb.	Bestell-Nr.	Maße (mm)	Leistung	Spannung	passend für
1	418704	255x240	1160W	400V	
2	418705	270x270	1335W	400V	Lohberger
3	418706	300x300	1505W	400V	

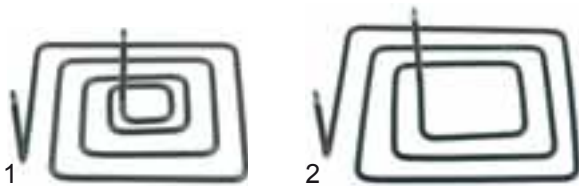

Abb.	Bestell-Nr.	Maße (mm)	Leistung	Spannung	Montage	passend für
1	415577	245x295	1160W	400V	innen	
2	415576	275x320	1335W	400V	mitte	Therma Electrolux
3	415575	360x395	1505W	400V	außen	

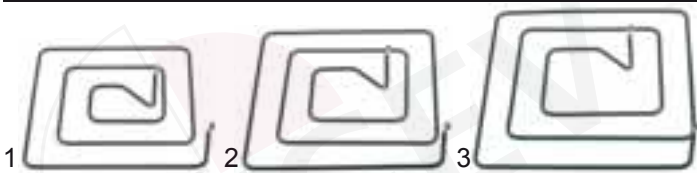

Abb.	Bestell-Nr.	Maße (mm)	Leistung	Spannung	passend für
1	415205	300x220	1700W	400V	Ambach
2	415206	355x340	2000W	400V	

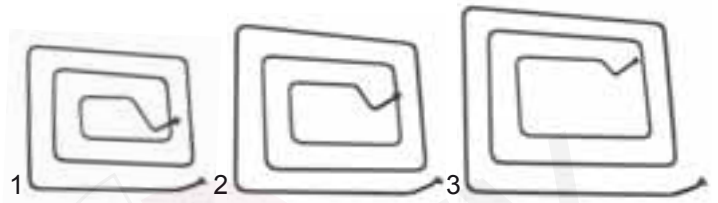

Abb.	Bestell-Nr.	Maße (mm)	Leistung	Spannung	passend für
1	416948	275x305	1700W	400V	Ambach
2	416949	300x340	2000W	400V	

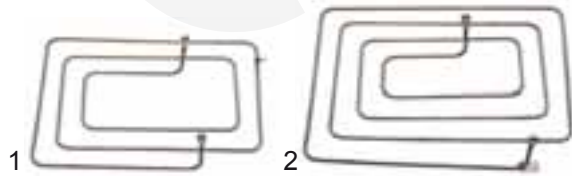

Abb.	Bestell-Nr.	Maße (mm)	Leistung	Spannung	passend für
1	415862	218x228	1350W	400V	Ambach
2	415863	245x260	1650W	400V	

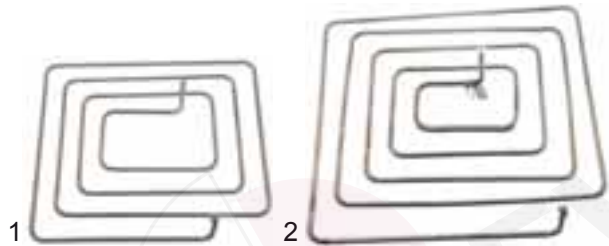

Abb.	Bestell-Nr.	Maße (mm)	Leistung	Spannung	passend für
1	418707	230x265	1500W	230V	EKU
2	418706	300x300	1500W	230V	

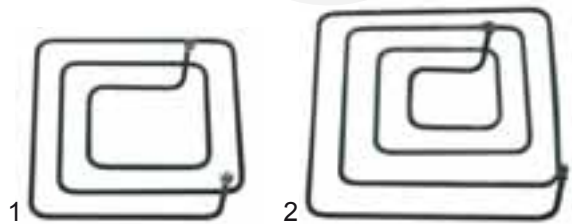

Abb.	Bestell-Nr.	Maße (mm)	Leistung	Spannung	Montage	passend für
1	418486	230x230	900W	400V	innen	Salvis Franke
2	418485	258x258	1100W	400V	mitte innen	

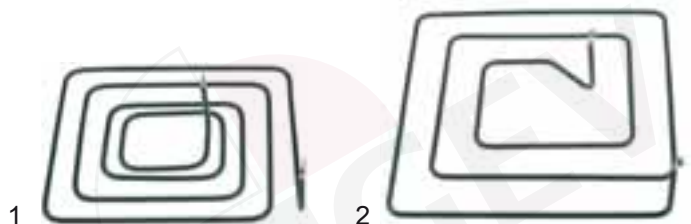

Abb.	Bestell-Nr.	Maße (mm)	Leistung	Spannung	Montage	passend für
1	418484	284x284	1300W	400V	mitte außen	Salvis Franke
2	418483	315x315	650W	400V	außen	

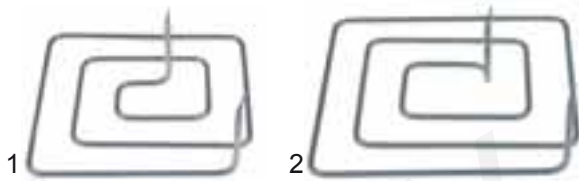

Abb.	Bestell-Nr.	Maße (mm)	Leistung	Spannung	passend für
1	418255	330x54	600W	80V	MKN 700 Serie
2	490022	ø145	1000W	230V	MKN 850 Serie

Strahlungsheizkörper

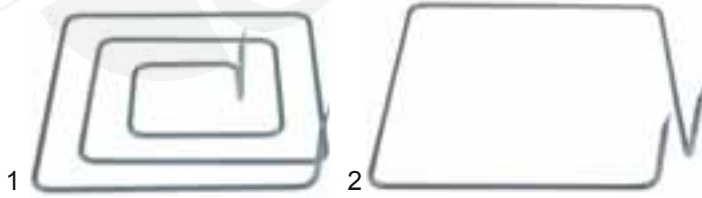

Abb.	Bestell-Nr.	ø (mm)	Leistung	Spannung	passend für
1	490139	250	2500/1100W	230V	Ascobloc Küppersbusch Palux Mareno
2	490146	250	2500/1250W	230V	Ascobloc Küppersbusch Palux



Abb.	Bestell-Nr.	Maße (mm)	Leistung	Spannung	passend für
1	416963	230x230	2400W	230V	Mareno
2	490152	300x300	2500W	230V	Mareno
3	490079	300x300	3400W	230V	Mareno



Abb.	Bestell-Nr.	Maße (mm)	Leistung	Spannung	passend für
1	490168	295x295	3500W	400V	Ascobloc
2	490159	300x300	3500W	240V	Zanussi Electrolux

Strahlungsheizkörper rund 1-kreisig Siebentaktregelung

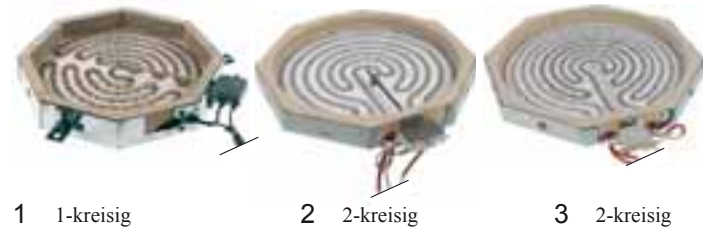

Abb.	Bestell-Nr.	ø (mm)	Leistung	Spannung	Anschlüsse	Fabrikat	Vergleichs-Nr.
1	490045	165	1200W	230V	4+2	EGO	10.74431.004
1	490046	200	1700W	230V	4+2	EGO	10.78431.004
1	490047	230	2100W	230V	4+2	EGO	10.71431.004
2	490169	165	1200W	230V	4	EGO	10.74433.004
2	490170	200	1700W	230V	4	EGO	10.78433.004
2	490132	230	2100W	230V	4	EGO	10.71421.004 10.71423.004 10.81351.004

Strahlungsheizkörper rund 2-kreisig Energieregelung (Spiralheizung)



Abb.	Bestell-Nr.	ø (mm)	Leistung	Spannung	Anschlüsse	Fabrikat	Vergleichs-Nr.
1	490040	200	1800/ 600W	230V	3+2	EGO	10.78661.004 10.87261.004
1	490028	230	2100/ 650W	230V	3+2	EGO	10.71261.004 10.81261.004
2	490146	250	2500/ 1250W	230V	3	EGO	10.73601.004

Energieregelung (Spiralheizung)



Abb.	Bestell-Nr.	ø (mm)	Leistung	Spannung	Anschlüsse	Fabrikat	Vergleichs-Nr.
1	490024	165	1200W	230V	2+2	EGO	10.74631.004
1	490025	200	1700W	230V	2+2	EGO	10.78631.004
1	490026	230	2100W	230V	2+2	EGO	10.71631.004
1	490150	250	2500W	230V	2+2	EGO	10.73631.004
2	490092	200	1800W	230V	2+2	Cerama Speed	200N4-2599

Energieregelung (Wellenblattheizung)



Abb.	Bestell-Nr.	ø (mm)	Leistung	Spannung	Anschlüsse	Fabrikat	Vergleichs-Nr.
1	490119	200	1700/ 600W	230V	3+2	EGO	10.58211.004
1	490044	230	2200/ 750W	230V	3+2	EGO	10.51211.004
1	490139	250	2500/ 1100W	230V	3+2	EGO	10.53211.004
2	490135	230	2200/ 750W	230V	3+2	EGO	10.51213.004
3	490157	230	2200/ 1000W	230V	3+2	EGO	10.51213.432

Energieregelung (Wellenblattheizung)



Abb.	Bestell-Nr.	ø (mm)	Leistung	Spannung	Anschlüsse	Fabrikat	Vergleichs-Nr.
1	490041	165	1200W	230V	2+2	EGO	10.54111.004
1	490042	200	1800W	230V	2+2	EGO	10.58111.004
1	490043	230	2300W	230V	2+2	EGO	10.51111.004
1	490136	230	2300W	230V	2+2	EGO	10.51113.004
1	490131	250	2500W	230V	2+2	EGO	10.53111.106
2	490051	230	2300W	230V	2+2	EGO	10.51121.004
3	490116	165	1200W	230V	2+2	Cerama Speed	165N8 L6090
3	490113	200	1800W	230V	2+2	Cerama Speed	200N8 L5708R
3	490091	230	2100W	230V	2+2	Cerama Speed	230N7- L4728R

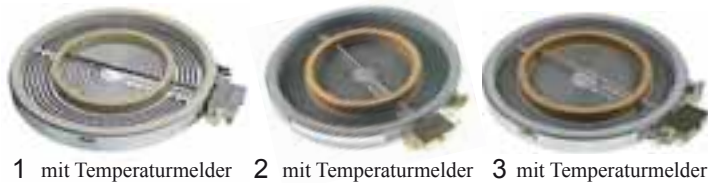

Pos.	Bestell-Nr.	ø (mm)	Leistung	Spannung	Anschlüsse	Fabrikat	Vergleichs-Nr.
1	490114	230	2200/ 750W	230V	3+2	Cerama Speed	230T8- L6384D

Strahlungsheizkörper achteckig 1-kreisig Energieregelung (Spiralheizung)



Abb.	Bestell-Nr.	Maße (mm)	Leistung	Spannung	Anschlüsse	Fabrikat	Vergleichs-Nr.
1	490151	230x230	2100W	230V	2+2	AD	100.382
2	416963	230x230	2400W	230V	2+2	AD	100.154

Strahlungsheizkörper achteckig 2-kreisig Energieregelung (Spiralheizung)

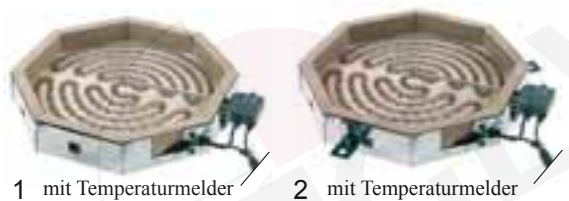

1 mit Temperatormelder 2 mit Temperatormelder 3 mit Temperatormelder

Abb.	Bestell-Nr.	Maße (mm)	Leistung	Spannung	Anschlüsse	Fabrikat	Vergleichs-Nr.
1	490152	300x300	2500W	230V	3+2	AD	100.298
2	490079	300x300	3400W	230V	4+2	AD	100.299 100.381
3	490153	300x300	3400W	230V	4+2	AD	100.370

Strahlungsheizkörper quadratisch



Abb.	Bestell-Nr.	Maße (mm)	Leistung	Spannung	Anschlüsse	passend für
1	416192	225x225	750W	230V	2	CF
2	490168	295x295	3500W	400V	2+2	Ascobloc



1 ohne Topferkennung 2 mit Topferkennung

Abb.	Bestell-Nr.	Maße (mm)	Leistung	Spannung	Anschlüsse	Fabrikat	Vergleichs-Nr.
1	490144	300x300	2500W	400V	3	EGO	10.77828.001
1	490159	300x300	3500W	230V	3	EGO	10.77828.002 10.77828.003 10.83816.120
1	490145	300x300	3500W	400V	3	EGO	10.77828.008
1	490008	300x300	4000W	400V	3	EGO	10.83816.060 10.77823.006
2	490108	300x300	2500W	400V	3+2	EGO	10.77848.001
2	490143	300x300	3500W	400V	3+2	EGO	10.77848.008
2	490009	300x300	4000W	400V	3+2	EGO	10.77843.006 10.83846.060

Strahlungsheizkörper rechteckig/doppelt Ceranherde



ohne Topferkennung

Pos.	Bestell-Nr.	Maße (mm)	Leistung	Spannung	passend für
1	416895	300x530	2x2600W	230V	Küppersbusch, Ascobloc



1 ohne Topferkennung 2 mit Topferkennung

Abb.	Bestell-Nr.	Maße (mm)	Leistung	Spannung	Fabrikat	Vergleichs-Nr.
1	490148	300x570	2x2500W	400V	EGO	10.83050.005
2	490147	300x570	2x3500W	230V	EGO	10.77058.019

Strahlungsheizkörper rechteckig diverse



Abb.	Bestell-Nr.	Maße (mm)	Leistung	Spannung	Anschlüsse	passend für
1	416015	135x150	600W	230V	2	Polydor
2	490142	133x151	750W	230V	2	Inoksan
3	416165	170x180	1500W	230V	2	Star 10



Abb.	Bestell-Nr.	Maße (mm)	Leistung	Spannung	Anschlüsse	passend für
1	418260	175x211	1600W	230V	2	Naomi
2	416001	165x265	1500W	230V	2	Bartscher Giorik

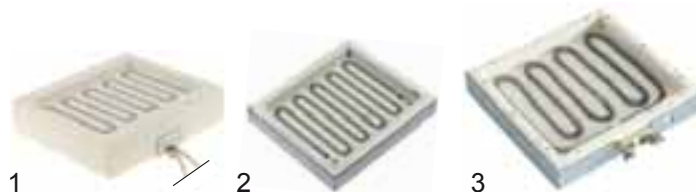

Abb.	Bestell-Nr.	Maße (mm)	Leistung	Spannung	Anschlüsse	Fabrikat	Vergleichs-Nr.
1	416655	240x290	2000W	230V	2	IRCA	3027287
2	416656	240x492	2x2000W	230V	2+2	IRCA	6349400

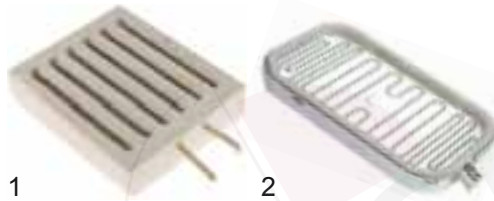

Pos.	Bestell-Nr.	Maße (mm)	Leistung	Spannung	Anschlüsse	Fabrikat	Vergleichs-Nr.
1	490172	280x400	4500W	400V	2x2	IRCA	W220 8178148

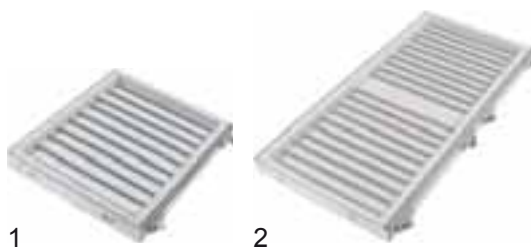

Abb.	Bestell-Nr.	Maße (mm)	Leistung	Spannung	Anschlüsse	Fabrikat	Vergleichs-Nr.
1	416166	175x380	3x1100W	230V	3x2	IRCA	X809 7100601
2	416897	275x415	3500W	400V	2x2	-	100456



Abb.	Bestell-Nr.	Maße (mm)	Leistung	Spannung	Anschlüsse	Fabrikat	Vergleichs-Nr.
1	416545	193x452	1500W	230V	2	AD	100
2	416546	276x452	2500W	230V	2	AD	100.105

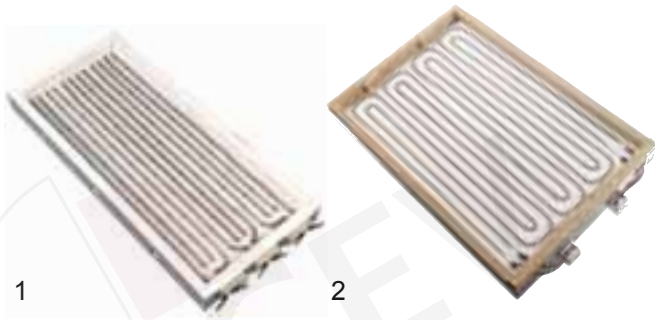

Abb.	Bestell-Nr.	Maße (mm)	Leistung	Spannung	Anschlüsse	Fabrikat	Vergleichs-Nr.
1	418029	193x450	1500	230V	2	IRCA	V117005
2	418030	295x450	2500	230V	2	IRCA	V110018

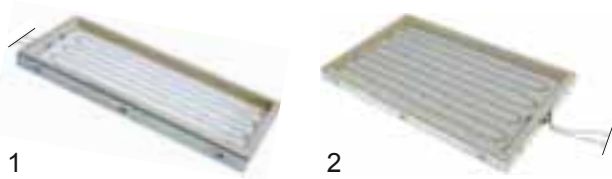

Abb.	Bestell-Nr.	Maße (mm)	Leistung	Spannung	Anschlüsse	Fabrikat	Vergleichs-Nr.
1	416998	165x410	3x900W	230V	3x2	IRCA	8025319
2	416999	280x410	3x1667W	230V	3x2	IRCA	4508
3	418000	340x432	3x3000W	400V	3x2	IRCA	7278571 4509

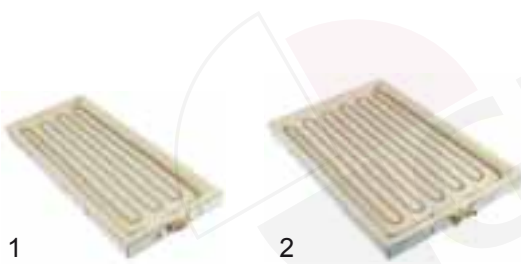

Abb.	Bestell-Nr.	Maße (mm)	Leistung	Spannung	Anschlüsse	Fabrikat	Vergleichs-Nr.
1	416934	480x470	3x1300W	400V	3x2	-	-
2	416937	320x455	3x1050W	230V	3x2	-	-

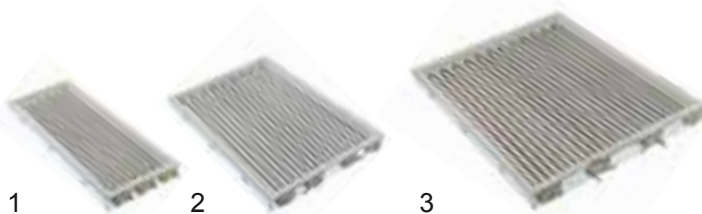

Abb.	Bestell-Nr.	Maße (mm)	Leistung	Spannung	Anschlüsse	Fabrikat	Vergleichs-Nr.
1	418230	260x425	3x1334W	230V	3x2	IRCA	4155 6296132
2	416921	295x462	2500W	230V	2	-	-

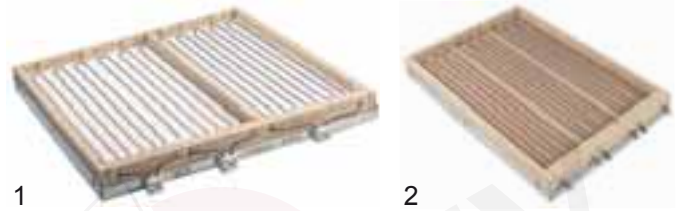

Abb.	Bestell-Nr.	Maße (mm)	Leistung	Spannung	Anschlüsse	Fabrikat	Vergleichs-Nr.
1	416939	285x650	2x860W	230V	2x2	-	-
2	490156	400x280	3x3000W	400V	6	AD	100.204

Zubehör Kochplatten

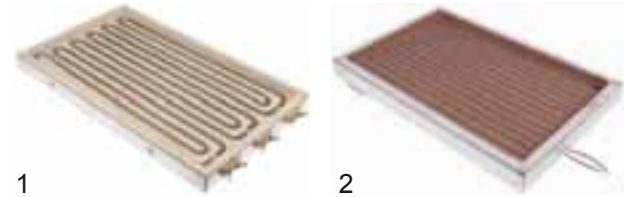
Diverses

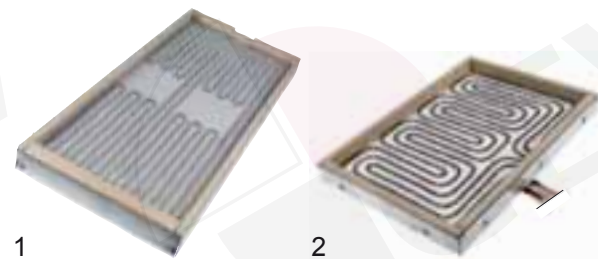

Abb.	Bestell-Nr.	Beschreibung	EGO-Nr.
1	550127	Anschlussstück 3+1	17.34310.000
2	550128	Anschlussstück 4+1	17.34410.000
3	550129	Lagerschraube	

Viertaktschalter 16A



Abb.	Bestell-Nr.	Anschluss	Signal	Achsenlänge (mm)	EGO-Nr.
1	300007	2-polig	ja	23	49.24215.520
2	300022	2-polig	nein	23	49.24015.500



Abb.	Bestell-Nr.	Anschluss	Signal	Achsenlänge (mm)	EGO-Nr.
1	300023	2-polig	ja	23	49.24215.000
2	300094	2-polig	ja	15	49.24215.001

Viertaktschalter 32A



Abb.	Bestell-Nr.	Anschluss	Signal	Achsenlänge (mm)	EGO-Nr.
1	300192	2-polig	nein	23	43.24032.000
2	300103	2-polig	ja	23	43.24232.000



Abb.	Bestell-Nr.	Anschluss	Signal	Achsenlänge (mm)	EGO-Nr.
1	300194	2-polig	ja	23	43.24216.000
2	300110	2-polig	ja	35	43.24216.020



Abb.	Bestell-Nr.	Anschluss	Signal	Achsenlänge (mm)	EGO-Nr.
1	300174	2-polig	ja	23	43.24432.000
2	300104	3-polig	ja	23	43.34232.000

Fünftaktschalter 16A

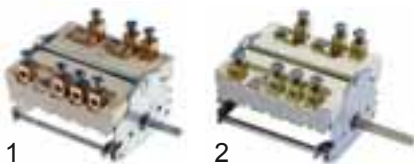

Pos.	Bestell-Nr.	Anschluss	Signal	Achsenlänge (mm)	EGO-Nr.
1	345199	2-polig	ja	23	49.25215.530

Fünftaktschalter 32A



Abb.	Bestell-Nr.	Anschluss	Signal	Achsenlänge (mm)	EGO-Nr.
1	300133	2-polig	ja	23	43.25232.000
2	300105	3-polig	ja	23	43.35232.000



Pos.	Bestell-Nr.	Anschluss	Signal	Achsenlänge (mm)	EGO-Nr.
1	300075	2-polig	ja	23	43.25232.020

Siebtaktschalter 16A



Abb.	Bestell-Nr.	Anschluss	Signal	Achsenlänge (mm)	EGO-Nr.
1	300031	2-polig	ja	23	46.27266.500
2	300177	2-polig	ja	23	46.27266.813



Abb.	Bestell-Nr.	Anschluss	Signal	Achsenlänge (mm)	EGO-Nr.
1	301250	2-polig	ja	23	46.27266.817
2	300079	2-polig	ja	23	46.27262.010

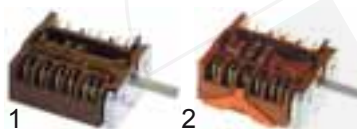

Abb.	Bestell-Nr.	Anschluss	Signal	Achsenlänge (mm)	EGO-Nr.
1	300026	2-polig	nein	27	49.27016.200
2	300024	2-polig	nein	23	49.27015.000
3	300003	2-polig	nein	23	49.27015.500

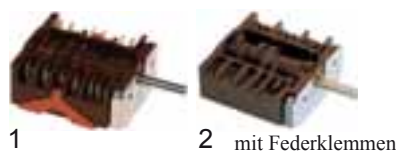

Abb.	Bestell-Nr.	Anschluss	Signal	Achsenlänge (mm)	EGO-Nr.
1	300025	2-polig	ja	27	49.27215.000 49.27215.746
2	300004	2-polig	ja	23	49.27215.520 49.27215.747 49.27215.500

Siebentaktschalter 32A



Pos.	Bestell-Nr.	Anschluss	Signal	Achsenlänge (mm)	EGO-Nr.
1	300106	3-polig	ja	23	43.27232.000

Energierregler 1-kreisig EGO



Abkürzungen:
 R = rechtsdrehend
 L = linksdrehend
 L1 = Lochabstand 28mm
 M1 = M12x1
 M2 = 3/8" - 24UNF

Abb.	Bestell-Nr.	Schaltleistung	Funktion	Befestigung	Achsenlänge (mm)	Leistungs-freigabe	Schaltbild	Vergleichs-Nr.
1	380015	13A/230V	R	L1	23	6-100%	1	50.57021.010 50.37021.000 50.17021.000
1	380019	13A/240V	R	L1	23	6-100%	1	50.57071.010 50.37071.000
1	380034	13A/240V	R	L1	23	6-100%	1	50.57079.021
1	380013	7A/400V	R	L1	23	6-100%	1	50.57031.010 50.37051.060 50.17031.000
1	380009	13A/230V	L	L1	23	6-100%	1	50.57020.010 50.37010.000 50.57010.010
1	380014	7A/400V	L	L1	23	6-100%	1	50.57030.010
2	380036	13A/230V	R	M1	23	6-100%	1	50.57024.010
2	380035	13A/240V	L	M2	19	22-100%	2	50.59070.048
2	380046	13A/240V	L	M2	23	22-100%	2	50.59070.051

Energierregler 1-kreisig DREEFS

Auslauftyp nur für Ersatzzwecke



Abkürzungen:
 R = rechtsdrehend
 L = linksdrehend
 L1 = Lochabstand 28mm

Abb.	Bestell-Nr.	Schaltleistung	Funktion	Befestigung	Achsenlänge (mm)	Leistungs-freigabe	Schaltbild	Vergleichs-Nr.
1	380005	16A/230V	L	L1	23	6-100%	8	SRIII/300
2	380017	16A/230V	R	L1	23	6-100%	8	SRIII/229

Energierregler 1-kreisig DIAMOND



Abkürzungen:
 R = rechtsdrehend
 L1 = Lochabstand 28mm
 M2 = 3/8" - 24UNF

Abb.	Bestell-Nr.	Schaltleistung	Funktion	Befestigung	Achsenlänge (mm)	Leistungs-freigabe	Schaltbild	Vergleichs-Nr.
1	380032	13A/230V	R	L1	23	6-100%	1	45ER104C1
2	380038	13A/24V	R	M2	26	6-100%	3	35ERE105024V
2	380037	13A/230V	R	M2	26	6-100%	3	35ERE101230V
2	380039	13A/400V	R	M2	26	6-100%	3	35ERE104400V

Energierregler 1-kreisig ROBERTSHAW



Abkürzungen:
 L = linksdrehend
 L2 = Lochabstand 19mm
 M2 = 3/8" - 24UNF

Abb.	Bestell-Nr.	Schaltleistung	Funktion	Befestigung	Achsenlänge (mm)	Leistungs-freigabe	Schaltbild	Vergleichs-Nr.
1	380041	15A/240V	L	L2	23	5-100%	2	INF2401165
1	380042	15A/240V	L	L2	35	22-100%	2	INF240TP1211
1	380043	15A/240V	L	L2	35	5-100%	2	INF240TP1211B
2	380044	15A/240V	L	M2	26	22-100%	2	INF240.2B

Energierregler 1-kreisig SUNVIC



Abkürzungen:
 R = rechtsdrehend
 M2 = 3/8" - 24UNF

Abb.	Bestell-Nr.	Schaltleistung	Funktion	Befestigung	Achsenlänge (mm)	Leistungs-freigabe	Schaltbild	Vergleichs-Nr.
1	380040*	13A/240V	R	M2	27	5-100%	4	TYJ6202(01B)
2	112520	Knebel (Achsenaufnahme 4,8x4,1mm)						

* Achtung: Achse 4,8x4,1mm

Energierregler 2-kreisig EGO



Pos.	Bestell-Nr.	Schaltleistung	Funktion	Befestigung	Achsenlänge (mm)	Leistungs-freigabe	Schaltbild	Vergleichs-Nr.
1	380027	13A/230V	R	L1	23	6-100%	5	50.55021.100 50.55071.100
2	380028	7A/400V	R	L1	23	6-100%	5	50.55031.100

Energieregler 2-kreisig EGO



Abkürzungen:
R = rechtsdrehend
L1 = Lochabstand 28mm

Abb.	Bestell-Nr.	Schaltleistung	Funktion	Befestigung	Achsenlänge (mm)	Leistungs-freigabe	Schaltbild	Vergleichs-Nr.
1	380004	13A/230V	R	L1	23	6-100%	6	50.67021.590
2	380024	13A/230V	R	L1	23	6-100%	7	50.67079.601

Thermostate



Abb.	Bestell-Nr.	Beschreibung	passend für	Vergleichs-Nr.
1	375425	Thermostat 360°C, 1-polig	Juno	76.77123.000
2	375570	Thermostat 470°C, 1-polig	Electrolux	55.34683.040



Abb.	Bestell-Nr.	Beschreibung	passend für	Vergleichs-Nr.
1	375105	Thermostat 500°C, 1-polig	Ambach	EM-1 60/60001999
2	375533	Thermostat 440°C, 3-polig		EMF-123 TN 60002163



Abb.	Bestell-Nr.	Beschreibung	passend für	Vergleichs-Nr.
1	375038	Thermostat 300°C, 3-polig	Juno Electrolux	55.34055.020
1	375872	Thermostat 490°C, 3-polig Fühler 90° gebogen	Wamsler	55.34083.050
2	375096	Thermostat 450°C, 4-polig	MKN Ascobloc	55.40083.010
3	375879	Thermostat 440°C, 3-polig	Lohberger	55.34683.060
3	375691	Thermostat 390°C, 3-polig	Palux	55.34673.010



Abb.	Bestell-Nr.	Temperaturbereich	Drehwinkel (°)	Kontakte	Vergleichs-Nr.
1	375246	100-645°C	270	2NO	55.34683.010
2	375140	100-650°C	318	2NO INC	55.34683.800



Abb.	Bestell-Nr.	Beschreibung	passend für	Vergleichs-Nr.
1	300080	Vorsatzschalter	Mareno	49.41015.300
2	550060	Bügel		
3	375884	Thermostat 400		55.19082.812

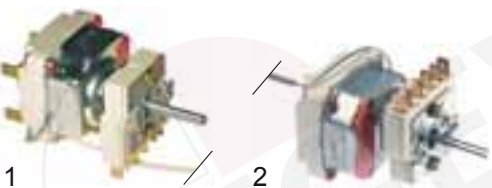

Abb.	Bestell-Nr.	Beschreibung	passend für	Vergleichs-Nr.
1	375877	Thermostat	Therma Electrolux	55.34083.220 49.41015.300
2	375773	Begrenzer 440°C	Küppersbusch Palux Ascobloc	55.13183.020



Abb.	Bestell-Nr.	Beschreibung	passend für	Vergleichs-Nr.
1	375878	Sicherheitsthermostat 570°C	Lohberger	55.32582.040
1	375681	Sicherheitsthermostat 520°C	Palux	55.32582.030
1	375890	Sicherheitsthermostat 650°C	Silko	55.32583.809
2	390609	Anlegethermostat	Küppersbusch Palux Ascobloc	
3	375880	Thermostat 57°C Lüfter	EKU	55.13312.050

Elektronikregelung



Abb.	Bestell-Nr.	Beschreibung	passend für	Vergleichs-Nr.
1	346984	Schalter mit Potentiometer		0K5063 180255422
2	379092	Fühler	Therma Electrolux	0K5058 18025415
3	379094	Fühlerhalter 39mm		0G2155
3	378128	Fühlerhalter 59mm		0KE127



Abb.	Bestell-Nr.	Beschreibung	passend für	Vergleichs-Nr.
1	401671	Halbleiterrelais		0K5070 18025431
2	401964	Elektronik	Therma Electrolux	0K5071 18025432
3	358397	Sicherung 25A		0K5074 18025434

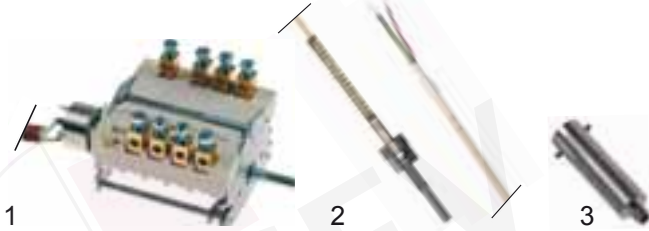

Abb.	Bestell-Nr.	Beschreibung	passend für	Vergleichs-Nr.
1	346593	Schalter		1G960000
2	379882	Fühler	Salvis Franke	1G943000
3	379881	Fühlerhalter		1G534536

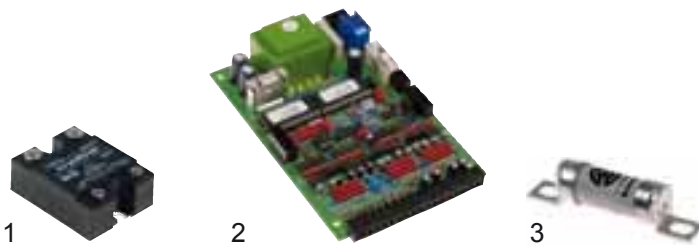

Abb.	Bestell-Nr.	Beschreibung	passend für	Vergleichs-Nr.
1	401563	Halbleiterrelais	Salvis	1G533279
2	401562	Elektronik	Franke	1G534537

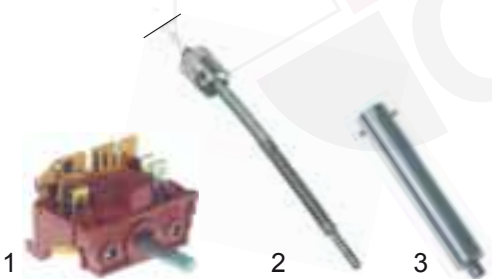

Abb.	Bestell-Nr.	Beschreibung	passend für	Vergleichs-Nr.
1	300002	Vorsatzschalter 4-polig		245599
2	400178	Potentiometer	Juno Electrolux	0H7178 867041
3	400079	Triac		0H7060 585601

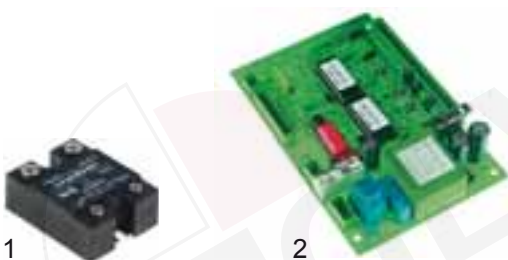

Abb.	Bestell-Nr.	Beschreibung	passend für	Vergleichs-Nr.
1	379148	Fühler	Juno	0H6267
2	400177	Elektronikthermostat	Electrolux	0H6144



Abb.	Bestell-Nr.	Beschreibung	passend für	Vergleichs-Nr.
1	347015	Schalter		0101420
2	402055	Potentiometer	Silko	0101932
3	350086	Summer		919008

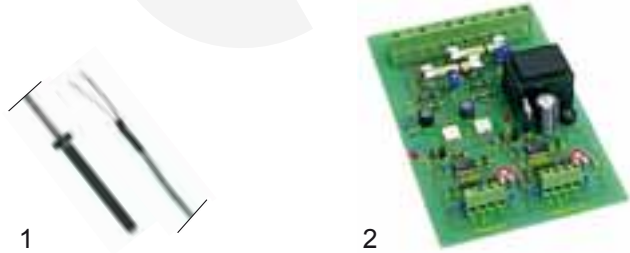

Abb.	Bestell-Nr.	Beschreibung	passend für	Vergleichs-Nr.
1	378129	Fühler	Silko	0100167
2	402056	Elektronik		0101930



Pos.	Bestell-Nr.	Beschreibung	Anwendung	Vergleichs-Nr.
1	400074	Topferkennungselektronik 400V für quadratische Elemente	Großküche	75.05011.000
2	400411	Topferkennungselektronik 230V für quadratische Elemente	Großküche	75.05011.001
3	401393	Topferkennungselektronik 230V für runde Elemente	Haushalt	75.05011.004

Knebel und Symbole

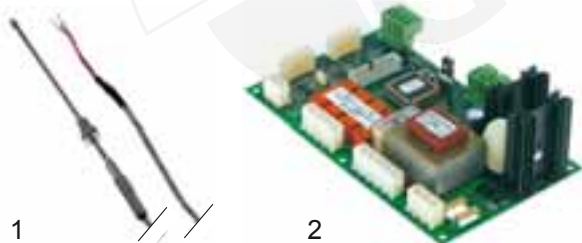

Abb.	Bestell-Nr.	Beschreibung
1	112489	Universalknebel ohne Adapter ø 52mm
2	112303	Universalknebel ohne Adapter ø 72mm
3	112311	Adapter 6x4,6



Abb.	Bestell-Nr.	Beschreibung
1	110521	Viertaktsymbol
2	110507	Viertaktsymbol vorne
3	110508	Viertaktsymbol hinten
4	112416	Fünftaktsymbol



Abb.	Bestell-Nr.	Beschreibung
1	110522	Siebertaktsymbol
2	110509	Siebertaktsymbol vorne
3	110510	Siebertaktsymbol hinten
4	112444	Thermostatsymbol 1-10 DW 270°

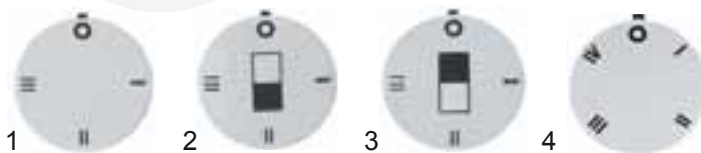

Abb.	Bestell-Nr.	Beschreibung
1	112445	Thermostatsymbol 1-10 DW 318°
2	112521	Energiereglersymbol 1-kreisig linksdrehend
3	112430	Energiereglersymbol 1-kreisig rechtsdrehend
4	112431	Energiereglersymbol 2-kreisig rechtsdrehend

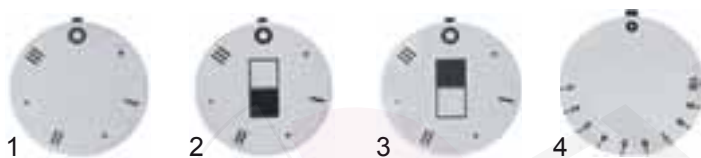

Abb.	Bestell-Nr.	Beschreibung
1	112173	Universalknebel ohne Adapter ø 62mm
2	112311	Adapter 6x4,6
3	112388	Mittelsymbol

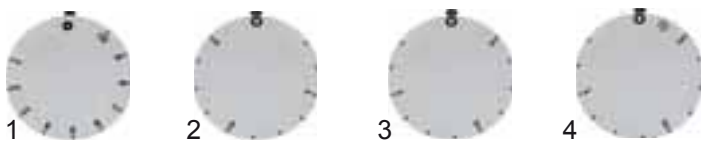

Abb.	Bestell-Nr.	Beschreibung
1	110553	Viertaktsymbol
2	111553	Fünftaktsymbol
3	110552	Siebertaktsymbol
4	110540	Thermostatsymbol 1-10 DW 270°



Abb.	Bestell-Nr.	Beschreibung
1	112295	Thermostatsymbol 1-10 DW 318°
2	112522	Energiereglersymbol 1-kreisig linksdrehend
3	110551	Energiereglersymbol 1-kreisig rechtsdrehend
4	111560	Energiereglersymbol 2-kreisig rechtsdrehend



Abb.	Bestell-Nr.	Beschreibung
1	112172	Universalknebel ohne Adapter ø 70mm
2	112311	Adapter 6x4,6



Abb.	Bestell-Nr.	Beschreibung
1	112212	Viertaktsymbol
2	112321	Fünftaktsymbol
3	112213	Siebertaktsymbol
4	112247	Thermostatsymbol 1-10 DW 270°



Abb.	Bestell-Nr.	Beschreibung
1	112249	Thermostatsymbol 1-10 DW 318°
2	112524	Energiereglersymbol 1-kreisig linksdrehend
3	112223	Energiereglersymbol 1-kreisig rechtsdrehend
4	112323	Energiereglersymbol 2-kreisig rechtsdrehend

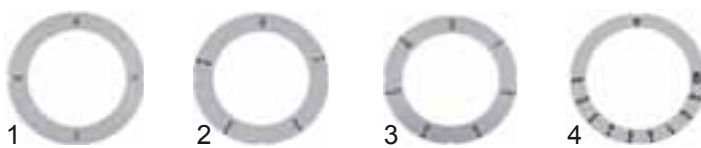

Abb.	Bestell-Nr.	Beschreibung
1	110232	Viertaktknebel ø 50mm
2	110233	Fünftaktknebel ø 50mm
3	110234	Siebertaktknebel ø 50mm
4	110235	Energieregler 1-3 ø 50mm

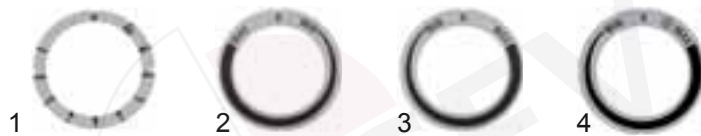

Abb.	Bestell-Nr.	Beschreibung
1	110237	Energieregler 1-10 rechtsdrehend ø 50mm
2	110238	Energieregler 1-10 linksdrehend ø 50mm
3	111861	Thermostat 1-10 DW 270°
4	110236	Thermostat DW 270° ø 50mm



Pos.	Bestell-Nr.	Beschreibung
1	110075	Energieregler 1-3 ø 50mm



Abb.	Bestell-Nr.	Beschreibung
1	110110	Viertaktknebel ø 60mm
2	110111	Fünftaktknebel ø 60mm
3	110112	Siebertaktknebel ø 60mm
4	110117	Energieregler 1-3 ø 60mm

Pflege- und Reparaturzubehör Glaskeramik



Abb.	Bestell-Nr.	Beschreibung
1	890238	Glaskeramikreiniger 200ml
2	890239	Glaskeramikreiniger 250g
3	890240	Glaskeramikscharber
4	890241	Ersatzklingen VPE 10 Stück

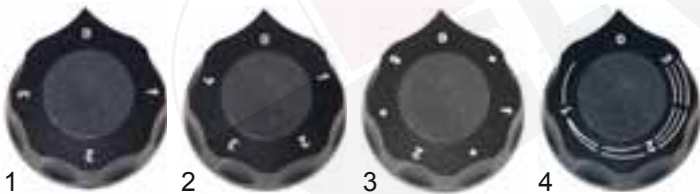
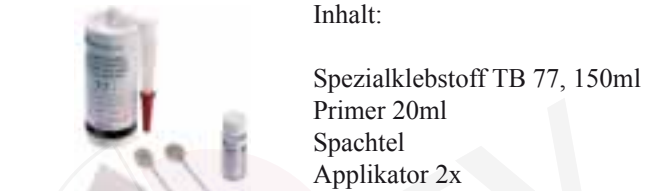

Inhalt:

Spezialklebstoff TB 77, 150ml
Primer 20ml
Spachtel
Applikator 2x

Pos.	Bestell-Nr.	Beschreibung
1	890242	Reparatur-Klebeset für Cerankochfelder (TOMABOND)



Abb.	Bestell-Nr.	Beschreibung
1	890257	Primer Haftvermittler 125ml
2	890258	Spezialklebstoff TB 77, 310ml, Farbe anthrazit (TOMABOND)
3	890060	Spezialklebstoff Pactan 310ml

Dichtschnüre rund, gedreht

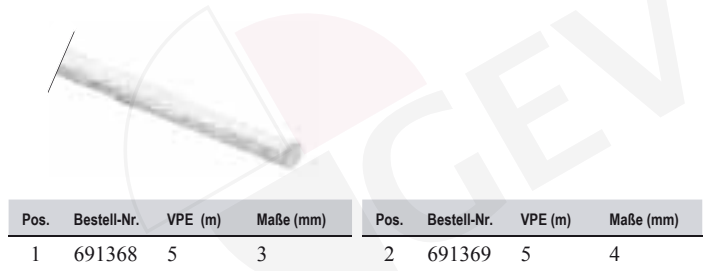

Pos.	Bestell-Nr.	VPE (m)	Maße (mm)	Pos.	Bestell-Nr.	VPE (m)	Maße (mm)
1	691368	5	3	2	691369	5	4

Dichtschnüre rund, geflochten

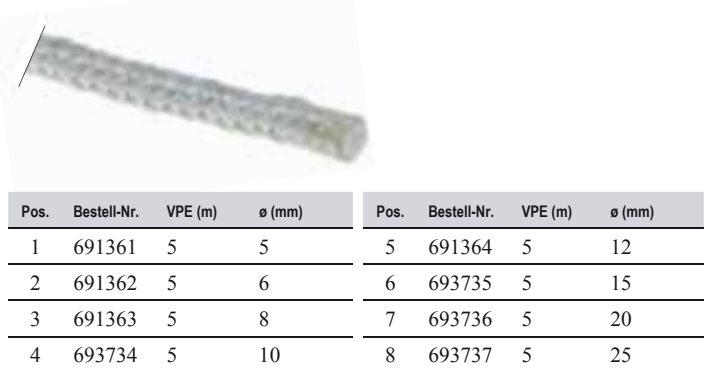

Pos.	Bestell-Nr.	VPE (m)	ø (mm)	Pos.	Bestell-Nr.	VPE (m)	ø (mm)
1	691361	5	5	5	691364	5	12
2	691362	5	6	6	693735	5	15
3	691363	5	8	7	693736	5	20
4	693734	5	10	8	693737	5	25

Dichtschnüre quadratisch, geflochten



Pos.	Bestell-Nr.	VPE (m)	Maße (mm)	Pos.	Bestell-Nr.	VPE (m)	Maße (mm)
1	691365	5	5x5	4	693738	5	10x10
2	691366	5	6x6	5	693739	5	12x12
3	691367	5	8x8	6	693740	5	14x14

EGOTHERM-Heizböden 1-kreisig



Abb.	Bestell-Nr.	Leistung	Spannung	Thermostat	Sicherheits-thermostat	EGO-Nr.
1	418473	1800W	230V	-	-	28.06018.300
2	415336	500W	230V	128°C (375300)	-	28.06013.100
2	415760	1800W	230V	128°C (375300)	-	28.06013.200
3	418429	1800W	230V	-	250°C (375137)	28.06020.000



Abb.	Bestell-Nr.	Leistung	Spannung	Thermostat	Sicherheits-thermostat	EGO-Nr.
1	418466	1800W	230V	128°C (375782)	-	28.06018.200
2	418430	1800W	230V	128°C (375782)	250°C (375137)	28.06020.100
2	418482	2000W	230V	128°C (375782)	250°C (375137)	28.06019.900

EGOTHERM-Heizböden 2-kreisig



Abb.	Bestell-Nr.	Leistung	Spannung	Thermostat	Sicherheits-thermostat	EGO-Nr.
1	415337	1800W	230V	128°C (375300)	250°C (375137)	28.06013.300
1	415661	3000W	230V	128°C (375300)	250°C (375137)	28.06013.400
2	418242	1800W	230V	117°C (375792)	250°C (375793)	28.06014.000
3	418467	1800W	230V	105°C (375794)	250°C (375137)	28.06019.500

Zubehör EGOTHERM-Heizböden Thermostate



Abb.	Bestell-Nr.	Temperaturbereich	Kapillare (mm)	EGO-Nr.
1	375300	35–128°C	880	55.14022.100
1	375792	30–117°C	990	55.14029.090
2	375794	30–105°C	870	55.13622.140
2	375782	30–128°C	870	55.13622.120

Sicherheitsthermostate



Abb.	Bestell-Nr.	Temperaturbereich	Kapillare (mm)	EGO-Nr.
1	375137	250°C	880	55.14542.040
1	375793	250°C	990	55.14549.020
2	390410	200°C	-	960.009

Diverses

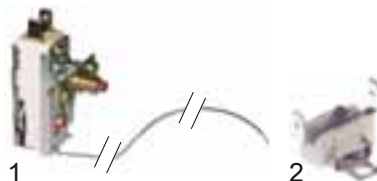

Abb.	Bestell-Nr.	Beschreibung
1	520324	Flanschplatte
2	520323	Dichtung

Schaltbilder Energieregler

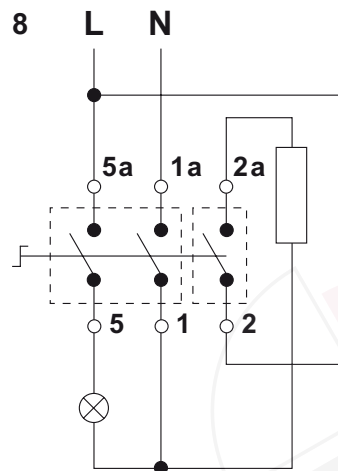
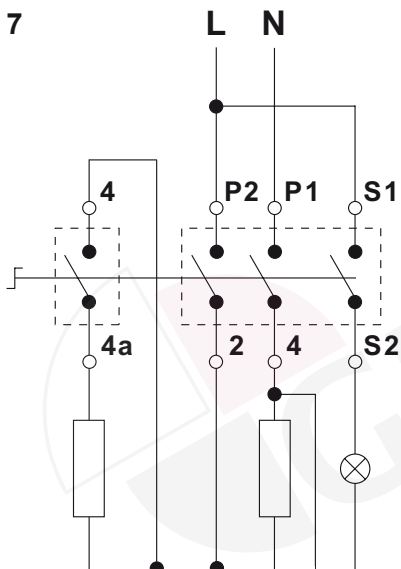
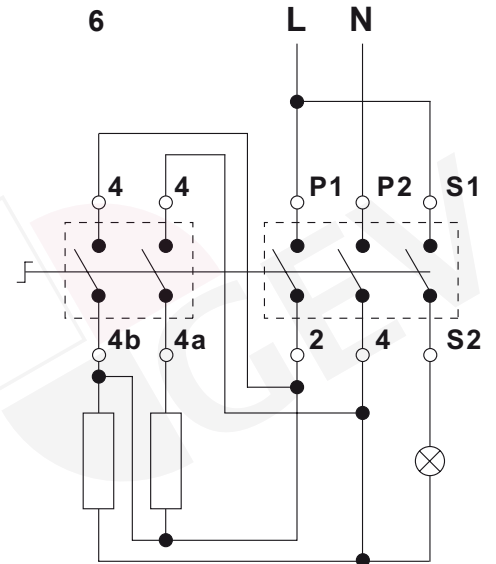
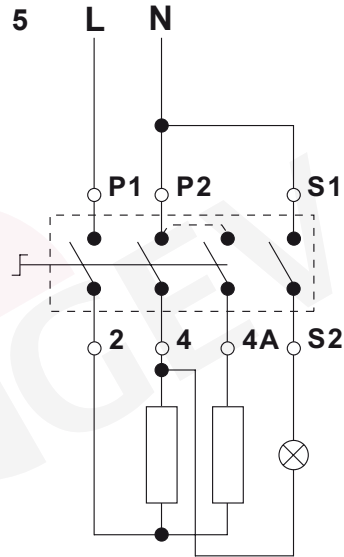
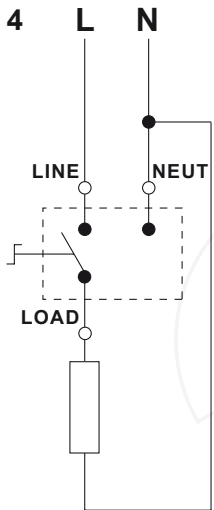
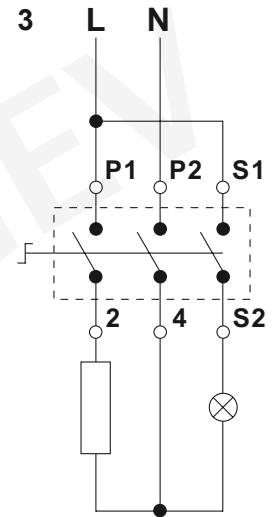
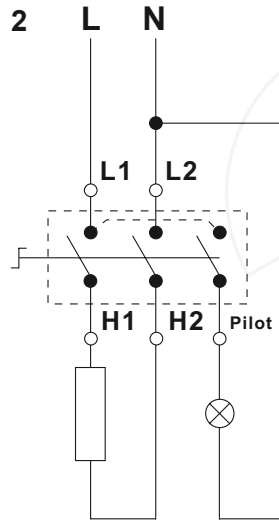
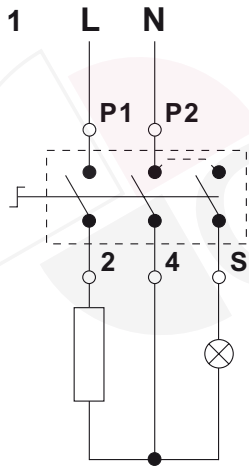

Schaltbilder Kochplatten

Kochplatte 3 Anschlüsse
2-poliger Viertaktschalter

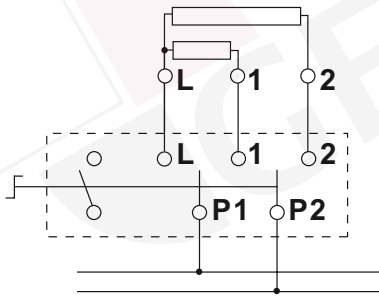

Kochplatte 4 Anschlüsse
2-poliger Viertaktschalter

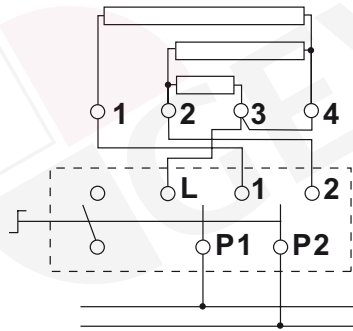

Kochplatte 4 Anschlüsse
2-poliger Fünftaktschalter

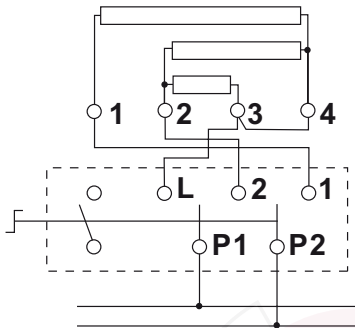

Kochplatte 4 Anschlüsse
2-poliger Siebentaktschalter

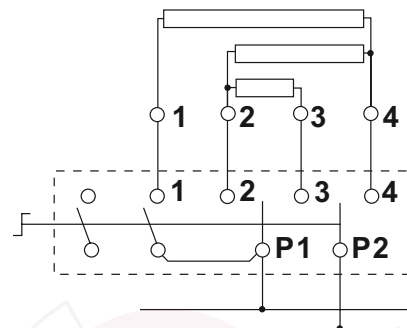

Kochplatte 4 Anschlüsse
3-poliger Viertaktschalter

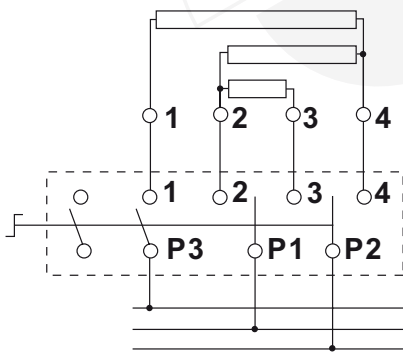

Kochplatte 4 Anschlüsse
3-poliger Fünftaktschalter

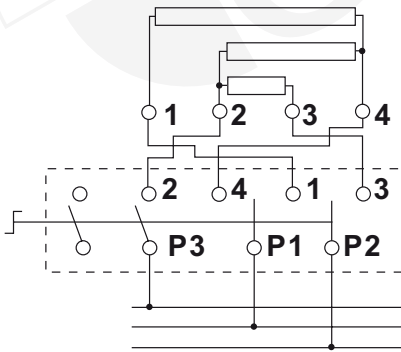

Kochplatte 2x3 Anschlüsse
2x2-poliger Viertaktschalter

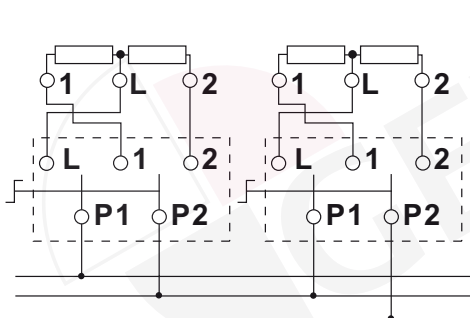

Kochplatte 2x3 Anschlüsse
1x3-poliger Viertaktschalter

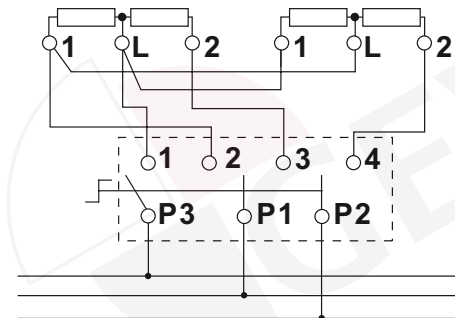

Kochplatten