



SCHALTER 3

Endschalter

S

Schalter 3

Mikroschalter



Positionsschalter



Magnetschalter



GEV GmbH
Großküchen-Ersatzteil-Vertrieb
Robert-Koch-Straße 3a
82152 Planegg/München
Deutschland

Telefon: +49 (0)89 745572-0
Telefax: +49 (0)89 745572-82
E-Mail: info@gev-online.de
Internet: www.gev-online.de



GEV GmbH
Ersatzteile und Zubehör
Kanalstrasse 14
5745 Safenwil
Schweiz

Telefon: +41 (0)62 797 87 70
Telefax: +41 (0)62 797 25 07
E-Mail: info@gev.ch
Internet: www.gev.ch



GEV Großküchen-
Ersatzteil-Vertriebs GesmbH
Austraße 12
5110 Oberndorf
Österreich

Telefon: +43 (0)6272 6688-0
Telefax: +41 (0)6272 6688-14
E-Mail: office@gev.at
Internet: www.gev.at

Members of the GEV GROUP

Mikroschalter Typ A



Seite 4

Mikroschalter Typ B



Seite 4

Mikroschalter Typ C



Seite 6

Mikroschalter Typ D und Typ E



Seite 7

Spezialschalter



Seite 7

Schwimmerschalter



Seite 8

Positionsschalter



Seite 9

Magnetschalter rund

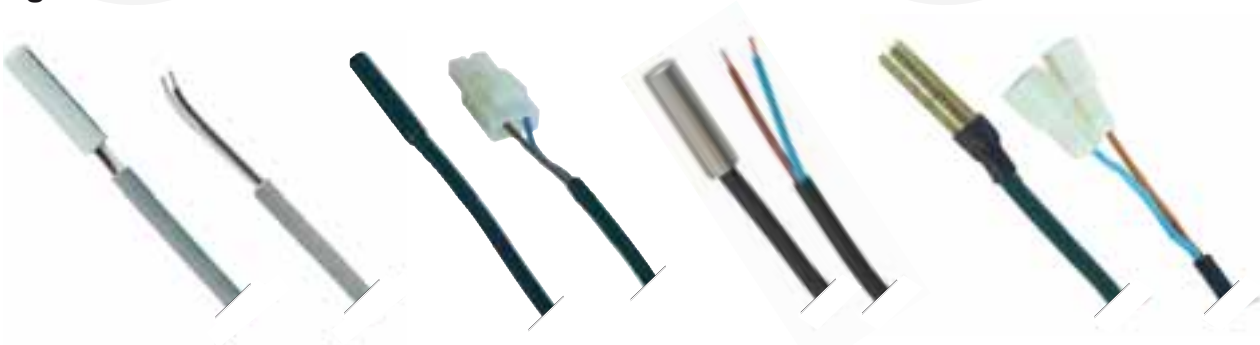

Seite 11

Magnetschalter flach



Seite 11

Magnete



Seite 14

Schwimmerschalter und Sonderschalter



Seite 15

Mikroschalter Typ A Mikroschalter Universal



Abb.	Bestell-Nr.	Funktion	Schaltleistung	Anschluss
1	345214	1CO	6A/250V	Kabel 500mm
2	345229	Hebelsatz	-	-
3	347006	1NO	10A/250V	Kabel 700mm



Abb.	Bestell-Nr.	Funktion	Schaltleistung	Anschluss
1	346141	1NO	10A/250V	Faston 2,8mm
2	346137	1CO	10A/250V	Löt
3	347026	1CO	5A/250V	Löt
4	347021	1CO	3A/250V	Löt



Abb.	Bestell-Nr.	Funktion	Schaltleistung	passend für	Vergleichs-Nr.
1	347034	1NO	-	Henkelmann	0900465
1	347035	1CO	-	Henkelmann	0900466
2	347032	1NO	10A/250V	Henkelmann	0900460
2	347033	1CO	10A/250V	Henkelmann	0900461

Mikroschalter Typ B Mikroschalter mit Hebel

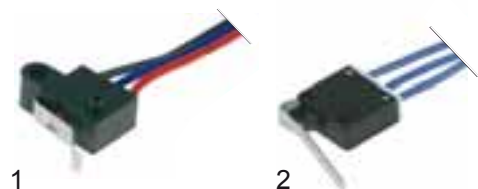

Pos.	Bestell-Nr.	L(mm)	Funktion	Schaltleistung	Anschluss (mm)
1	345256	26,5	1CO	16A/250V	Faston 6,3
2	345257	31,5	1CO	16A/250V	Faston 6,3
3	346456	36	1CO	0,1A/250V	Faston 6,3
4	345255	36	1CO	16A/250V	Faston 6,3
5	347010	36	1CO	16A/250V	Faston 4,8
6	346969	50	1NO	16A/250V	Faston 6,3
7	345742	56	1CO	16A/250V	Faston 6,3
8	346872	58	1CO	0,1A/250V	Faston 6,3
9	345773	60	1CO	16A/250V	Faston 6,3
10	345254	66	1CO	16A/250V	Faston 6,3
11	345345	69	1CO	16A/250V	Faston 6,3
12	346072	71	1CO	6A/250V	Faston 6,3
13	345107	78/82/89	1CO	16A/250V	Faston 6,3

Mikroschalter mit Rollhebel

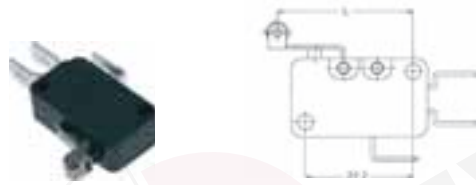

Pos.	Bestell-Nr.	L(mm)	Funktion	Schaltleistung	Anschluss (mm)
1	345041	20,5	1CO	16A/250V	Faston 6,3
2	345252	25	1CO	16A/250V	Faston 6,3
3	345253	30	1CO	16A/250V	Faston 6,3
4	345250	34,5	1CO	16A/250V	Faston 6,3
5	345251	41	1CO	16A/250V	Faston 6,3

Mikroschalter universal



Abb.	Bestell-Nr.	Funktion	Schaltleistung	Anschluss
1	345042	1CO	16A/250V	Faston 6,3mm
2	300158	1CO	8A/250V	Kabel 1500mm
3	345043	Hebelsatz	-	-

Basisschalter



Abb.	Bestell-Nr.	Funktion	Schaltleistung	Anschluss (mm)
1	345105	1CO	16A/250V	Faston 6,3mm
2	346158	1CO	5A/250V	Faston 4,8mm
3	346145	1CO	10A/250V	Faston 4,8mm
4	347043	1NC	16A/250V	Faston 4,8mm

Mikroschalter mit Spezialhebel



Abb.	Bestell-Nr.	Funktion	Anschluss (mm)	passend für	Vergleichs-Nr.
1	345059	1CO	Faston 6,3	Comenda	120323
2	345178	1CO	Faston 6,3	Elframo	25190003
3	346333	1NO	Faston 6,3	Lotus	537025300
4	346159	1CO	Faston 6,3	Rancilio	34100004



Abb.	Bestell-Nr.	Funktion	Anschluss (mm)	passend für	Vergleichs-Nr.
1	345363	1CO	Faston 6,3	Faber	1035
2	345699	1NO	Faston 6,3	Roller Grill	A07017
3	345791	1CO	Faston 6,3	Gastrofrit	306.040.045

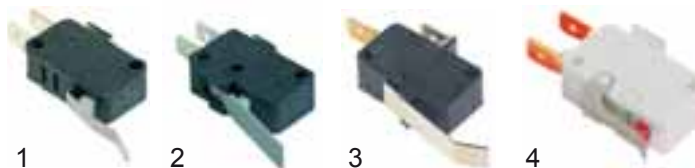

Abb.	Bestell-Nr.	Funktion	Anschluss (mm)	passend für	Vergleichs-Nr.
1	346314	1CO	Faston 6,3	Tecnoeka	9951727000
2	345279	1CO	Faston 6,3	ITV	100388
3	300152	1CO	Faston 6,3	Gico	784106510



Abb.	Bestell-Nr.	Funktion	Anschluss (mm)	passend für	Vergleichs-Nr.
1	345368	1CO	Faston 6,3	Staff	90/82010000
2	346152	1CO	Faston 6,3	Mazzer	S00SMIA04
3	345367	1CO	Faston 6,3	Staff	10318000

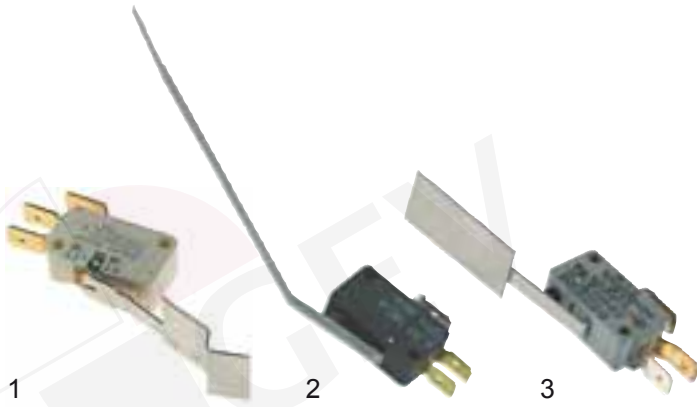

Abb.	Bestell-Nr.	Funktion	Anschluss (mm)	passend für	Vergleichs-Nr.
1	345515	1CO	Faston 6,3	IME Omniwash	CEMP12CL
2	346876	1CO	Faston 6,3	Icematic	19410208
3	347008	1CO	Kabel	Electrolux	0E5629



Abb.	Bestell-Nr.	Funktion	Anschluss (mm)	passend für	Vergleichs-Nr.
1	346838	2CO	Faston 6,3	SMEG	814490215
2	346861	2CO	Faston 6,3	SMEG	814490182



Abb.	Bestell-Nr.	Funktion	Anschluss (mm)	passend für	Vergleichs-Nr.
1	345580	2NO	Faston 6,3	Elettrobar	218010
2	346927	2CO	Faston 6,3	Adler	20035

Mikroschalter mit Frontbefestigung

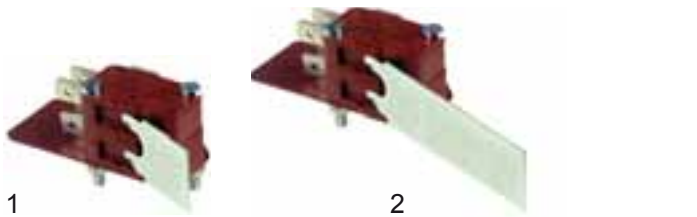

Abb.	Bestell-Nr.	Befestigung	Funktion	Schaltleistung	Anschluss (mm)
1	100010	M10x0,75mm	1CO	5A/250V	Faston 6,3
2	100038	M11x1mm	1CO	5A/250V	Faston 6,3
3	345425	M10x0,75mm	1CO	16A/250V	Faston 6,3



Abb.	Bestell-Nr.	Befestigung	Funktion	Schaltleistung	Anschluss (mm)
1	345032	M10x0,75mm	1CO	16A/250V	Faston 6,3
2	345350	M11x1mm	1CO	16A/250V	Faston 6,3



Abb.	Bestell-Nr.	Befestigung	Funktion	Schaltleistung	Anschluss (mm)
1	346369	M10x0,75mm	1CO	16A/250V	Faston 6,3
2	345104	M10x0,75mm Rollstößel	1CO	16A/250V	Faston 6,3

Spezialschalter



Abb.	Bestell-Nr.	Funktion	passend für	Vergleichs-Nr.
1	346387	1NO	Zanussi	56944
2	346274	1CO	Ambach	5060917629
3	346290	1CO	Juno	245474



Abb.	Bestell-Nr.	Befestigung	Funktion	Schaltleistung	Anschluss (mm)
1	347054	M10x0,75mm	2NO	16A/250V	Faston 6,3
2	346347	M10x0,75mm	2NO	16A/250V	Faston 6,3
3	300126	M11x1mm	2NO	16A/250V	Faston 6,3
4	345048	M12x1mm	2CO	16A/250V	Faston 6,3

Mikroschalter TYP C Mikroschalter mit Hebel



Pos.	Bestell-Nr.	L(mm)	Funktion	Schaltleistung
1	345268	38	1CO	16A/250V
2	345269	54	1CO	16A/250V
3	345125	63,5	1CO	16A/250V
4	345044	72	1CO	16A/250V
5	345270	133	1CO	16A/250V
6	345074	146,5	1CO	16A/250V
7	345271	152,5	1CO	16A/250V
8	346908	172	1CO	16A/250V

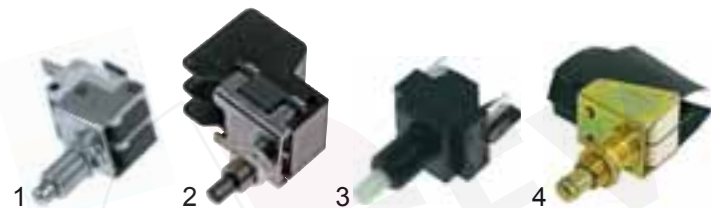

Abb.	Bestell-Nr.	L(mm)	Funktion	Schaltleistung
1	345121	73	1CO	16A/250V
2	346875	120	1CO	16A/250V



Pos.	Bestell-Nr.	Funktion	Schaltleistung
1	347051	1CO	16A/250V

Mikroschalter mit Rollhebel



Pos	Bestell-Nr.	L(mm)	Funktion	Schaltleistung
1	346874	25	1CO	16A/250V
2	345266	34,5	1CO	16A/250V
3	345045	50,5	1CO	16A/250V
4	345267	60	1CO	16A/250V

Mikroschalter mit Frontbefestigung



Abb.	Bestell-Nr.	Befestigung	Funktion	Schaltleistung
1	345156	M10x1mm	1CO	16A/250V
2	345138	M12x1mm	1CO	16A/250V
3	345258	M12x1mm	1CO	16A/400V



Abb.	Bestell-Nr.	Befestigung	Funktion	Schaltleistung
1	345679	M12x1mm	1CO	16A/250V
2	346370	M12x1mm	1CO	16A/250V
3	347009	M12x1mm	1CO	20A/250V

Mikroschalter Spezialausführung



Abb.	Bestell-Nr.	Funktion	Schaltleistung	passend für	Vergleichs-Nr.
1	346878	1CO	16A/250V	Brema	23373
2	345103	1CO	20A/400V	San Marco	



Abb.	Bestell-Nr.	Beschreibung	Funktion	Schaltleistung
1	345052	Hebel 53mm	1CO	10A/250V
2	345360	M12x1	1CO	10A/250V



Abb.	Bestell-Nr.	Funktion	passend für	Vergleichs-Nr.
1	346574	1CO	Juno	247396
2	346507	1CO	Küppersbusch	177161



Abb.	Bestell-Nr.	Funktion	passend für	Vergleichs-Nr.
1	345046	1NO+1NC	Eloma	VO600
2	345047	1CO	Rational	30161400
3	346289	1CO	Juno Electrolux	245481

Mikroschalter TYP D



Abb.	Bestell-Nr.	Funktion	Schaltleistung
1	345060	NO	16A/250V
2	345061	1NC	16A/250V
3	345062	1NO+1NC	16A/250V



Abb.	Bestell-Nr.	Funktion	Schaltleistung
1	345247	2NO	16A/250V
2	345326	1NO	16A/250V
3	305004	1NO+1NC	16A/250V
3	347050	1NC	16A/250V

Mikroschalter TYP E

Mikroschalter mit Schnappbefestigung



Abb.	Bestell-Nr.	Beschreibung	Funktion	Schaltleistung
1	345285	1polig	2NO	16A/250V
2	300092	1polig	2NO	16A/250V
3	345127	3polig	3NO	16A/250V

Spezialschalter



Abb.	Bestell-Nr.	Funktion	passend für	Vergleichs-Nr.
1	345735	1NO	STAR10	73002
2	345736	1NC	STAR10	73011



Abb.	Bestell-Nr.	Funktion	passend für	Vergleichs-Nr.
1	346904	1NO	Angelo Po	32W3700
2	345459	1NO	A.T.A.	7607
3	345460	1NO	A.T.A.	7620

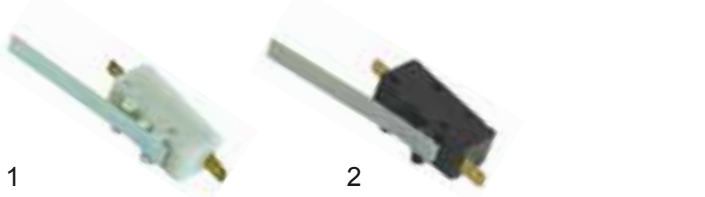

Abb.	Bestell-Nr.	Funktion	passend für	Vergleichs-Nr.
1	346909	1CO	Angelo Po	32W0010
2	346907	1CO	Angelo Po	32W0020
3	345585	1NO	Elettrobar	218003



Abb.	Bestell-Nr.	Funktion	passend für	Vergleichs-Nr.
1	345186	1CO	Elframo	25190001
2	345815	1NO	Zanussi	60722
3	347007	1NC	Zanussi	046322



Abb.	Bestell-Nr.	Funktion	passend für	Vergleichs-Nr.
1	346887	1NC	Scotsman	1200205901
2	345427	1CO	Fagor OEM	X343015 EG00100
3	345224	1NO	Honved	25552

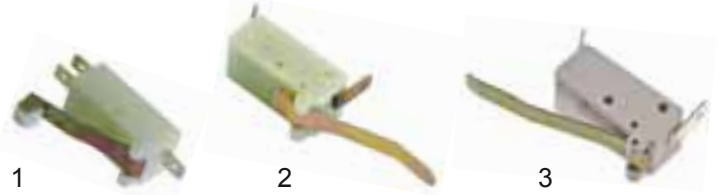

Abb.	Bestell-Nr.	Funktion	passend für	Vergleichs-Nr.
1	346865	1NO+1NC	CAB	1061/UL
2	345361	1NO+1NC	Icematic	1940205
3	345902	1NO+1NC	Bourgeois	INT103

Mikroschalter mit Spezialhalterung



Abb.	Bestell-Nr.	Funktion	Anschluss (mm)	passend für	Vergleichs-Nr.
1	345992	1CO	Faston 6,3	Winterhalter	62001349
2	345966	1CO	Faston 6,3	Winterhalter	5519007



Abb.	Bestell-Nr.	Funktion	Anschluss (mm)	passend für	Vergleichs-Nr.
1	345965	1CO	Faston 6,3	Winterhalter	5519024
2	346375	2CO	Faston 6,3	Küppersbusch	994902006

Schalter mit Schnappbefestigung

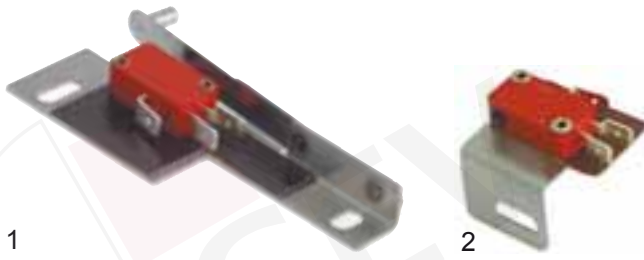

Abb.	Bestell-Nr.	Einbau (mm)	Funktion	Schaltleistung	Faston (mm)
1	345249	26x12	1NO	65W/250V	6,3
2	346569	26x13	1NO	25W/250V	6,3
3	346772	27x20	1CO	2,5A/250V	4,8

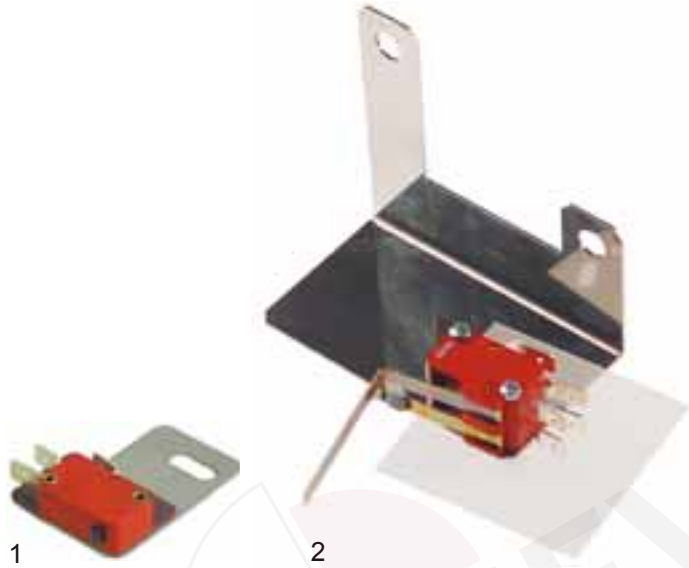

Abb.	Bestell-Nr.	Einbau (mm)	Funktion	Schaltleistung	Faston (mm)
1	346139	27x13,5	1CO	13A/250V	6,3
2	346166	27x13,6	1NC	10A/250V	4,8
3	347018	26x12	1CO	1A/250V	2,8

Schwimmerschalter



Abb.	Bestell-Nr.	Beschreibung	passend für	Vergleichs-Nr.
1	345365	Schalter komplett	Icematic	81449091
2	345373	Schalter komplett	BREMA	C26562
3	345042	Schalter		



Abb.	Bestell-Nr.	Beschreibung	passend für	Vergleichs-Nr.
1	345324	Schalter komplett	I.T.V.	105058
2	345279	Schalter	I.T.V.	100388



Abb.	Bestell-Nr.	Beschreibung	passend für	Vergleichs-Nr.
1	345372	Schalter komplett	Eurfrigor	RH000830
2	345367	Schalter	Eurfrigor	
3	695044	Schwimmer	Eurfrigor	RH000679

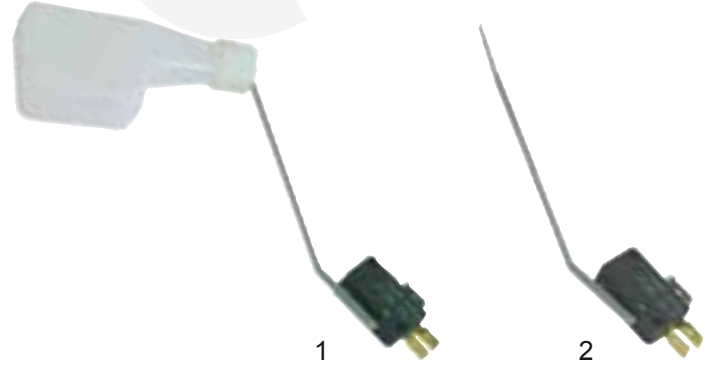

Abb.	Bestell-Nr.	Beschreibung	passend für	Vergleichs-Nr.
1	345371	Schalter komplett	Eurfrigor	RH00A310
2	345042	Schalter	Eurfrigor	
3	695044	Schwimmer	Eurfrigor	RH000679

Positionsschalter

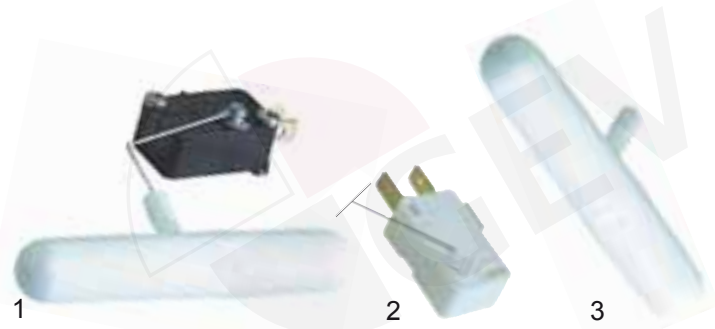
Positionsschalter Siemens

Kunststoffgehäuse IP65

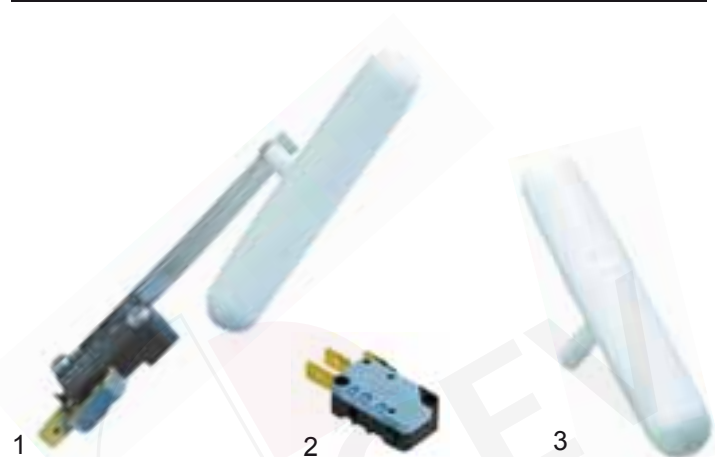
Basisgeräte erweiterbar mit Antriebsköpfen



Pos.	Bestell-Nr.	Beschreibung	Funktion
1	346604	Kuppenstößel	1NO+1NC
2	346605	Kuppenstößel	2NO
3	346606	Kuppenstößel	2NC

Antriebsköpfe



Abb.	Bestell-Nr.	Beschreibung	Abb.	Bestell-Nr.	Beschreibung
1	346607	Rollenstößel	3	346609	Winkelrollenhebel
2	346608	Rollenhebel	4	346610	Schwenkhebel



Abb.	Bestell-Nr.	Beschreibung	Abb.	Bestell-Nr.	Beschreibung
1	346611	Schwenkhebel längenverstellbar	3	346614	Zentralbefestigung M18x1
2	346613	Kuppenstößel mit Zentralbefestigung M18x1	4	346612	Federstab

Positionsschalter Siemens

Metallgehäuse IP65

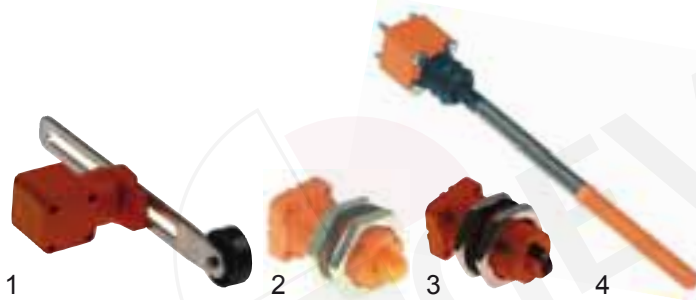

Pos.	Bestell-Nr.	Beschreibung	Funktion
1	346288	Rollenhebel	1NO+1NC

Positionsschalter Möller

Kunststoffgehäuse IP65

Basisgeräte für Frontbefestigung nicht erweiterbar



Pos.	Bestell-Nr.	Beschreibung	Funktion
1	347016	Kuppenstößel	1NO+1NC
2	345549	Kuppenstößel	2NO
3	347017	Kuppenstößel	2NC

Basisgeräte erweiterbar mit Antriebsköpfen



Pos.	Bestell-Nr.	Beschreibung	Funktion
1	346284	Kuppenstößel	1NO+1NC
2	346987	Kuppenstößel	2NO
3	346988	Kuppenstößel	2NC

Antriebsköpfe



Abb.	Bestell-Nr.	Beschreibung	Abb.	Bestell-Nr.	Beschreibung
1	346989	Rollenstößel	3	346991	Winkelrollenhebel
2	346990	Rollenhebel	4	346992	Schwenkhebel



Abb.	Bestell-Nr.	Beschreibung	Abb.	Bestell-Nr.	Beschreibung
1	346993	Schwenkhebel längenverstellbar	3	346995	Frontbefestigungs- adapter
2	346994	Federstab			

Positionsschalter Pizzato

Serie FR
Kunststoffgehäuse IP67

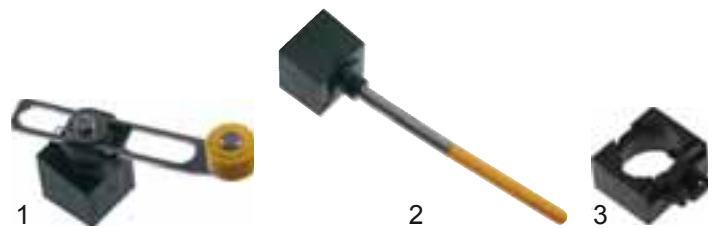

Abb.	Bestell-Nr.	Beschreibung	Funktion
1	345181	Kuppenstößel	INO+INC
2	345337	Kuppenstößel mit Dichtung	INO+INC
3	345338	Rollenstößel	INO+INC



Abb.	Bestell-Nr.	Beschreibung	Funktion
1	345389	Rollenhebel	INO+INC
2	345144	Schwenkhebel	INO+INC
3	345209	Winkelrollenhebel	INO+INC



Abb.	Bestell-Nr.	Beschreibung	Funktion
1	345487	Kuppenstößel mit Frontbefestigung M12x1	INO+INC
2	345488	Kuppenstößel mit Frontbefestigung M18x1	INO+INC
3	345508	Rollenstößel mit Frontbefestigung M18x1	INO+INC



Abb.	Bestell-Nr.	Beschreibung	Funktion
1	345509	Schwenkhebel längenverstellbar	INO+INC
2	345513	Federstab	INO+INC
3	347052	Schlüssel	INO+INC

Serie FB

Metallgehäuse IP67



Pos.	Bestell-Nr.	Beschreibung	Funktion
1	346175	Rollenstößel	INO+INC

Serie FD

Metallgehäuse IP67



Abb.	Bestell-Nr.	Beschreibung	Funktion
1	345058	Kuppenstößel mit Dichtung	INO+INC
2	345862	Rollenhebel	INO+INC



Abb.	Bestell-Nr.	Beschreibung	Funktion
1	345057	Schwenkhebel	INO+INC
2	345075	Stabhebel	INO+INC

Serie FA

Metallgehäuse IP67



Abb.	Bestell-Nr.	Beschreibung	Funktion
1	300137	Rollenstößel	INO+INC
2	345696	Rollenstößel mit Frontbefestigung M12x1	INO+INC
3	345697	Schwenkhebel	INO+INC

Positionsschalter Bernstein



Abb.	Bestell-Nr.	Beschreibung	Funktion	Schutzart.
1	345922	Kuppenstößel	INO+INC	IP30
2	346296	Rollenhebel	INO+INC	IP65
3	345921*	Rollenstößel	INO+INC	IP65

*Metallgehäuse IP67

Positionsschalter diverse



Abb.	Bestell-Nr.	Beschreibung	Funktion	Fabrikat
1	345040	Schwenkhebel	INO+INC	Crouzet
2	347053	Schlüssel	INO+INC	Lovato

Magnetschalter rund Bauart Kunststoff 4x19mm



Pos.	Bestell-Nr.	Funktion	Grenzwerte	Kabel (mm)
1	347049	1NO	-	1250

Bauart Kunststoff 5,75x25mm Typ MK3



Pos.	Bestell-Nr.	Funktion	Grenzwerte	Kabel (mm)
1	345967	1NO	0,5A/200V/10W	2000

Bauart Kunststoff 6x29mm Typ A061



Abb.	Bestell-Nr.	Funktion	Grenzwerte	Kabel (mm)
1	345146	1NO	1A/250V/50W	1000
2	345202	1NO	0,04A/250V/10W	1500
3	345819	1NO	1A/250V/50W	300

Bauart Metall 8x58mm

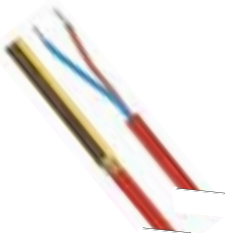

Pos.	Bestell-Nr.	Funktion	Kabel (mm)	passend für	Vergleichs-Nr.
1	346511	1NO	2900	Rational	30161417

Bauart Metall 9x31mm Typ B091



Pos.	Bestell-Nr.	Funktion	Grenzwerte	Kabel (mm)
1	345991	1NO	1A/250V/50W	2000
2	345429	1NO	0,04A/250V/10W	2000

Bauart Metall M8x0,75mm Typ D081



Pos.	Bestell-Nr.	Funktion	Grenzwerte	Kabel (mm)
1	345631	1NO	1A/250V/50W	2000

Bauart Metall M10x0,75mm Typ D102



Pos.	Bestell-Nr.	Funktion	Grenzwerte	Kabel (mm)
1	345632	1NO	1A/250V/50W	2000

Bauart Metall M12x1mm Typ D121



Pos.	Bestell-Nr.	Funktion	Grenzwerte	Kabel (mm)
1	345430	1NO	1A/250V/50W	2000

Bauart Metall M12x1mm Typ D122



Pos.	Bestell-Nr.	Funktion	Grenzwerte	Kabel (mm)
1	345135	1NO	1A/250V/50W	2000

Magnetschalter flach Bauart 32x15mm Typ MK12

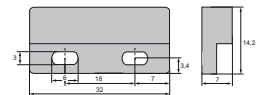

Pos.	Bestell-Nr.	Funktion	Grenzwerte	Kabel (mm)
1	345109	1NO (1A84)	0,5A/400V/10W	2000

Bauart 32x15mm Typ MK12



Pos.	Bestell-Nr.	Funktion	Grenzwerte	Kabel (mm)
1	345968	1NO (1A71)	0,5A/200V/10W	2000
2	345969	1NO (1A84)	0,5A/400V/10W	2000

Bauart 23x14mm Typ MK4



Pos.	Bestell-Nr.	Funktion	Grenzwerte	Kabel (mm)
1	346106	1NO	0,5A/90V/5W	500

Bauart 28,5x19mm Typ 59135

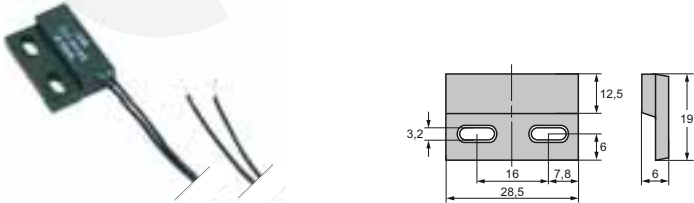

Pos.	Bestell-Nr.	Funktion	Grenzwerte	Kabel (mm)
1	345219	1NO	0,5A/250V/10W	800
2	345248	1NO	0,5A/250V/10W	300

Bauart 25x14mm Typ E540



Pos.	Bestell-Nr.	Funktion	Grenzwerte	Kabel (mm)
1	345217	1NO	0,5A/200V/10W	2000

Bauart 29x19mm Typ E560

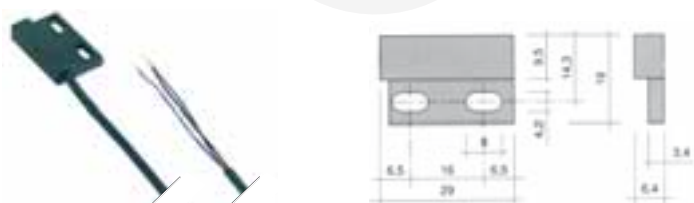

Pos.	Bestell-Nr.	Funktion	Grenzwerte	Kabel (mm)
1	345117	1NO	0,04A/250V/10W	1000
2	345808	1CO	0,5A/175V/10W	1000
3	345802	1NO	0,04A/250V/10W	5000

Bauart 28,6x18mm Typ MA11



Pos.	Bestell-Nr.	Funktion	Grenzwerte	Kabel (mm)
1	345807	1NO	0,5A/250V/10W	

Bauart 38,8x25,5mm Typ MA45

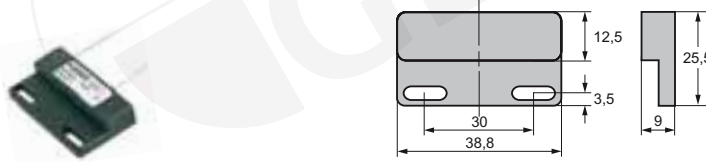

Pos.	Bestell-Nr.	Funktion	Grenzwerte	Kabel (mm)
1	345804	1NO	0,5A/250V/10W	

Bauart 36x13mm Typ E510



Pos.	Bestell-Nr.	Funktion	Grenzwerte	Kabel (mm)
1	345118	1NO	0,5A/250V/50W	1000

Bauart 36x13mm Typ E511



Abb.	Bestell-Nr.	Funktion	Grenzwerte	Kabel (mm)
1	345820	1NO	0,5A/250V/50W	300
2	345792	1NO	0,04A/250V/10W	2000

Bauart 37x16mm Typ E550

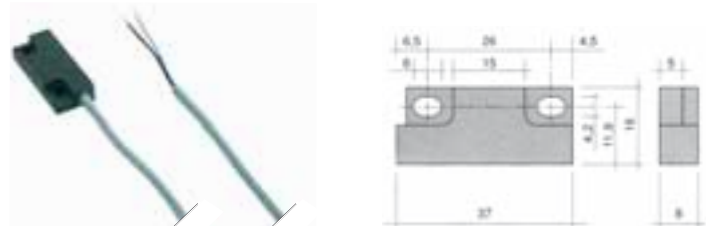

Pos.	Bestell-Nr.	Funktion	Grenzwerte	Kabel (mm)
1	345341	1NO	0,04A/250V/10W	2000
2	345600	1NO	0,5A/250V/50W	1000

Bauart 40x13mm Typ E521



Pos.	Bestell-Nr.	Funktion	Grenzwerte	Kabel (mm)
1	345358	1NO	0,04A/250V/10W	2000

Bauart 40x13mm Typ E522

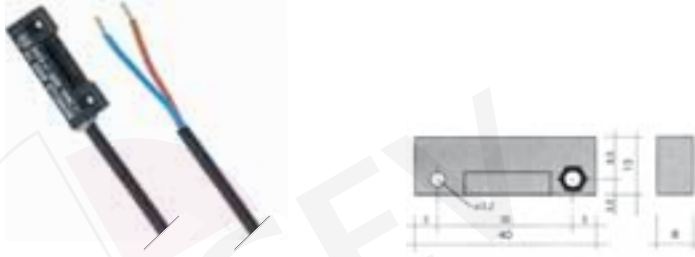

Pos.	Bestell-Nr.	Funktion	Grenzwerte	Kabel (mm)
1	345504	1NO	0,04A/250V/10W	2000

Bauart 40x13mm Typ E520



Pos.	Bestell-Nr.	Funktion	Grenzwerte	Kabel (mm)
1	345990	1NO	0,04A/250V/10W	2000

Bauart 65x20mm Typ E530



Pos.	Bestell-Nr.	Funktion	Grenzwerte	Kabel (mm)
1	345116	1NO	0,4A/250V/100W	3000
2	345122	1NO	8A/24V	340
3	346058	1NO	0,4A/250V/100W	90

Bauart 80x15mm



Pos.	Bestell-Nr.	Funktion	Grenzwerte	Kabel (mm)
1	345210	1NO	0,5A/265V/10W	600

Bauart 76x21mm Typ E580

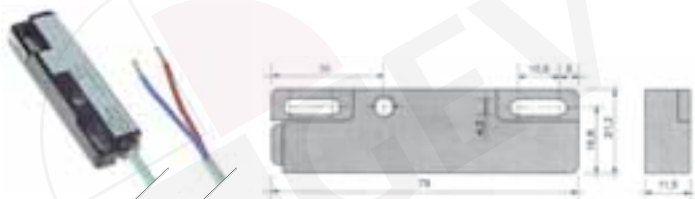

Pos.	Bestell-Nr.	Funktion	Grenzwerte	Kabel (mm)
1	345783	1NO	1A/250V/50W	600

Bauart 80x20mm Typ MA12



Pos.	Bestell-Nr.	Funktion	Grenzwerte	Kabel (mm)
1	345803	1CO	1A/250V/80W	2000
2	345801	1NIO	3A/250V/100W	5000

Bauart flach 80x30mm Typ MA44



Pos.	Bestell-Nr.	Funktion	Grenzwerte	Kabel (mm)
1	345919	1NO	3A/250V/100W	1250
2	345920	1NO	3A/250V/100W	1000
3	345918	1NO	0,2A/250V/100W	3500

Bauart 80x30mm Typ MA44



Pos.	Bestell-Nr.	Funktion	Grenzwerte	Kabel (mm)
1	345806	1CO	1A/250V/80W	6000

Bauart 36x26mm Typ E590/E591



Pos.	Bestell-Nr.	Funktion	Grenzwerte	Kabel (mm)
1	346998	1NO	3A/230V/60W	2000
2	347000	1NO	3A/230V/60W	5500
3	346999*	1NC	3A/230V/60W	2000

* Polarisiert - Bauart flach 35x22

Bauart 35x22mm



Pos.	Bestell-Nr.	Funktion	Grenzwerte	Kabel (mm)
1	347003	1NO	1A/230V/60W	1700

Bauart 50x19mm Typ E710

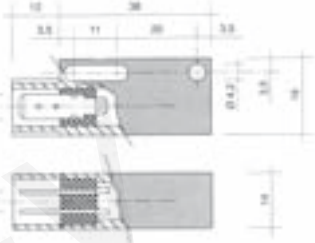

Pos.	Bestell-Nr.	Funktion	Grenzwerte	Anschluss (mm)
1	345821	1NO	1A/250V/50W	F6,3mm

Magnete Bauart rund



Pos.	Bestell-Nr.	Maße (mm)	Pos.	Bestell-Nr.	Maße (mm)
1	346891	ø6x13	4	346514	ø10x40
2	347002	ø6x30	5	346025	ø12x15
3	347047	ø10x3	6	347046	ø16x3

Bauart rechteckig

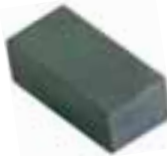

Pos.	Bestell-Nr.	Fläche (mm)	Länge (mm)	Pos.	Bestell-Nr.	Fläche (mm)	Länge (mm)
1	347045	5x12	24	2	345110	9x15	25

Bauart ringförmig



Pos.	Bestell-Nr.	Maße (mm)	Innen (mm)	Pos.	Bestell-Nr.	Maße (mm)	Innen (mm)
1	345486	ø20x6	ø3,2	2	347048	ø32,5x6	ø18

Bauart flach 25x14mm Typ M305

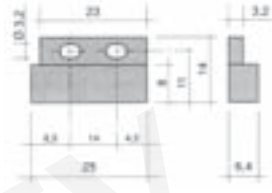

Pos.	Bestell-Nr.	Maße (mm)
1	345432	25x14

Bauart flach 24x16mm

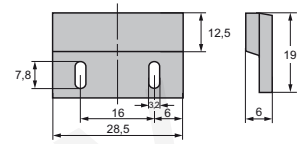

Pos.	Bestell-Nr.	Maße (mm)
1	345700	29x16

Bauart flach 29x16mm Typ M304



Pos.	Bestell-Nr.	Maße (mm)
1	345517	29x16

Bauart flach 36x13mm Typ M302

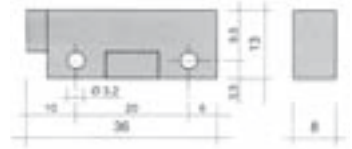

Pos.	Bestell-Nr.	Maße (mm)
1	345398	36x14

Bauart flach 37x16mm Typ M306

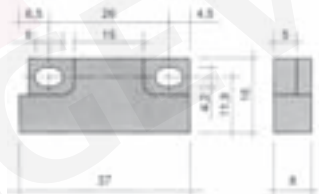

Pos.	Bestell-Nr.	Maße (mm)
1	345516	37x16

Bauart flach 40x13mm Typ M303

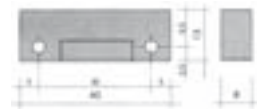

Pos.	Bestell-Nr.	Maße (mm)
1	345399	40x13

Bauart flach 45,5x18mm Typ M370



Pos.	Bestell-Nr.	Maße (mm)
1	345518	45,5x18

Bauart flach 63x18mm Typ M340

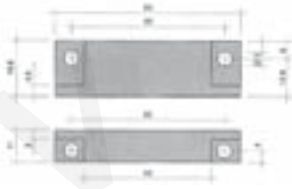

Pos.	Bestell-Nr.	Maße (mm)
1	345336	63x18

Bauart flach 63x18 Typ M350

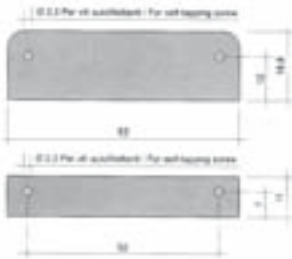

Pos.	Bestell-Nr.	Maße (mm)
1	519049	63x18

Bauart flach 76x23mm Typ M380

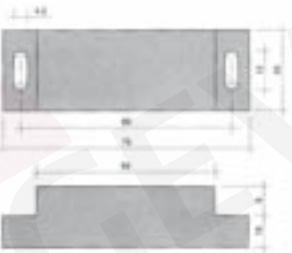

Pos.	Bestell-Nr.	Maße (mm)
1	345519	76x25

Bauart flach 88x25mm Typ M395

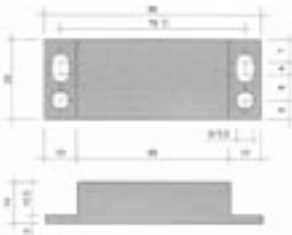

Pos.	Bestell-Nr.	Maße (mm)
1	345535	88x25

Bauart flach 23x15mm M375



Pos.	Bestell-Nr.	Maße (mm)
1	347001	23x15

Schwimmerschalter Schwimmerschalter Typ A (Einbau ø15mm)

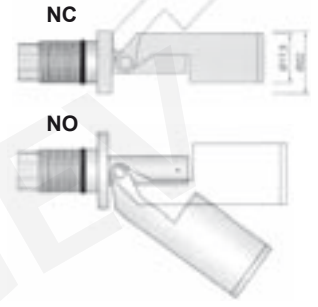

Pos.	Bestell-Nr.	Funktion	Grenzwerte	Anschluss (mm)
1	345446	1NO oder 1NC	0,13A/250V/32W	250

Schwimmerschalter Typ B (Einbau ø16mm)

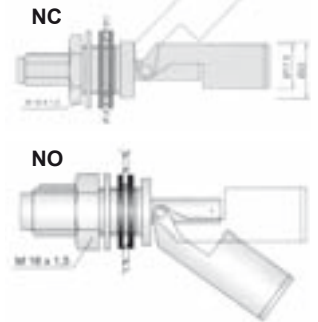

Pos.	Bestell-Nr.	Funktion	Grenzwerte	Anschluss (mm)
1	345484	1NO oder 1NC	1A/250V/50W	2000

Schwimmerschalter Typ C (Einbau ø22mm)

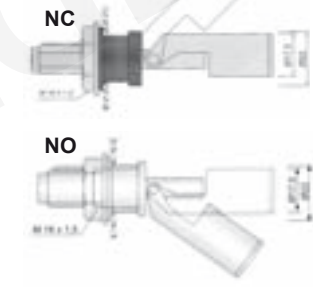

Pos.	Bestell-Nr.	Funktion	Grenzwerte	Kabel (mm)
1	345822	1NO oder 1NC	1A/250V/50W	2000

Schwimmerschalter Typ D (Einbau ø22mm)

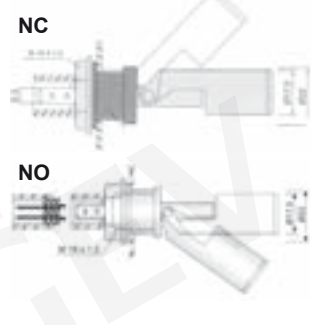

Pos.	Bestell-Nr.	Funktion	Grenzwerte	Anschluss (mm) (mm)
1	345447	1NO oder 1NC	1A/250V/50W	Faston 6,3

Schwimmerschalter Typ E (Einbau ø22mm)

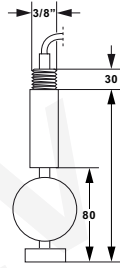

Pos.	Bestell-Nr.	Funktion	Grenzwerte	Kabel (mm)
1	400023	1CO	0,5A/230V/10W	1800



Pos.	Bestell-Nr.	Funktion	passend für	Vergleichs-Nr.
1	347042	1NO	Henkelmann	0220114



Pos.	Bestell-Nr.	Funktion	Grenzwerte	Kabel (mm)
1	401986	1NO	1A/220V/60W	330



Pos.	Bestell-Nr.	Funktion	passend für	Vergleichs-Nr.
1	402061	1NO	Hatco	802.01.249.00

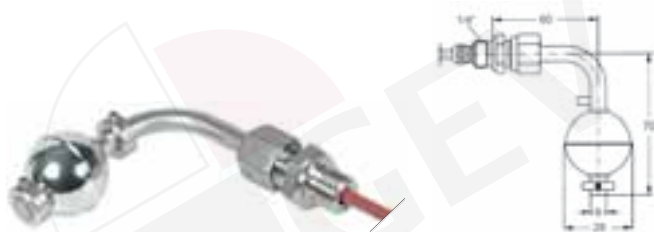

Pos.	Bestell-Nr.	Funktion	Grenzwerte	Kabel (mm)
1	401442	1NO	0,5A/250V/10W	2100

Näherungsschalter (induktiv)



Pos.	Bestell-Nr.	Einbau	Funktion	Grenzwerte	Kabel (mm)
1	345900	ø 12mm	1NO	0,2A/24-240V	2000
2	345698	ø 12mm	1NC	0,2A/24-240V	2000
3	346578	ø 18mm	1NO	0,35A/20-250V	2000

Fotoelektronischer Schalter



Pos.	Bestell-Nr.	Einbau	Funktion	Grenzwerte	passend für
1	401970	ø 18mm	1NO	0,1A/15-264V	Meiko

Lichtschranken



Abb.	Bestell-Nr.	passend für	Vergleichs-Nr.
1	402043	Scotsman	65067402 78508602
2	402009	Scotsman	65067400

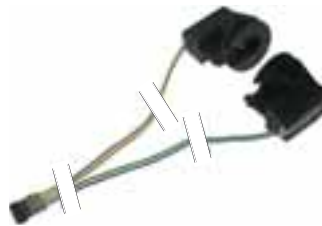

Pos.	Bestell-Nr.	passend für	Vergleichs-Nr.
1	402039	Scotsman	78508600 78508602R

